

1031

1



LEGO dacta

Technic

877313

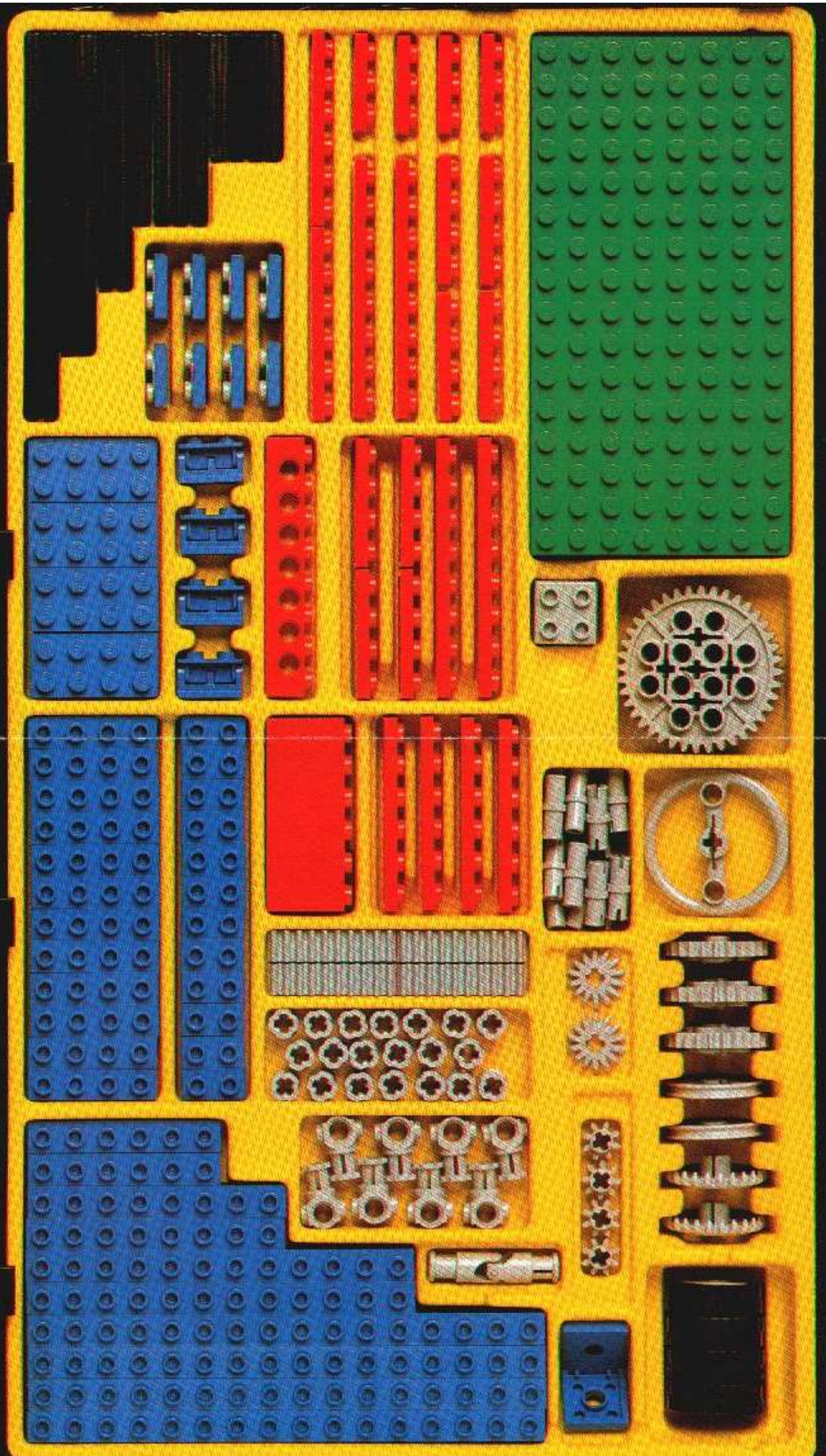

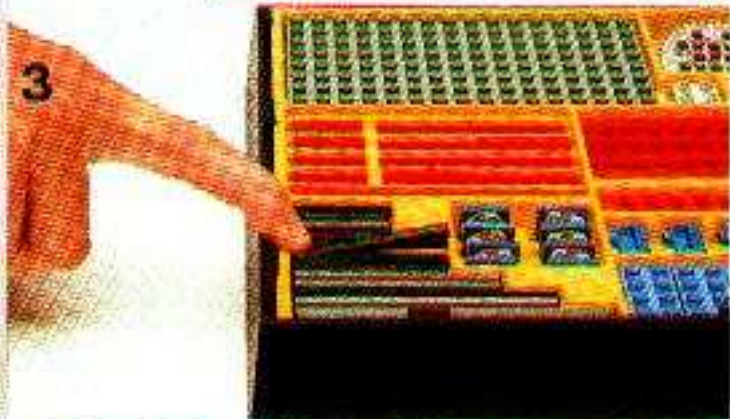
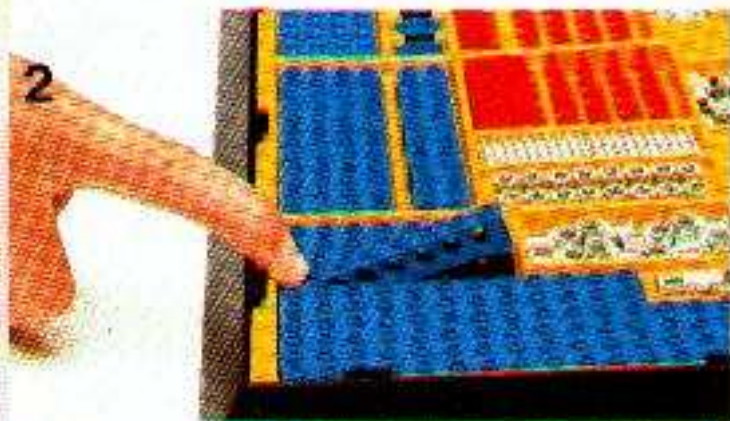
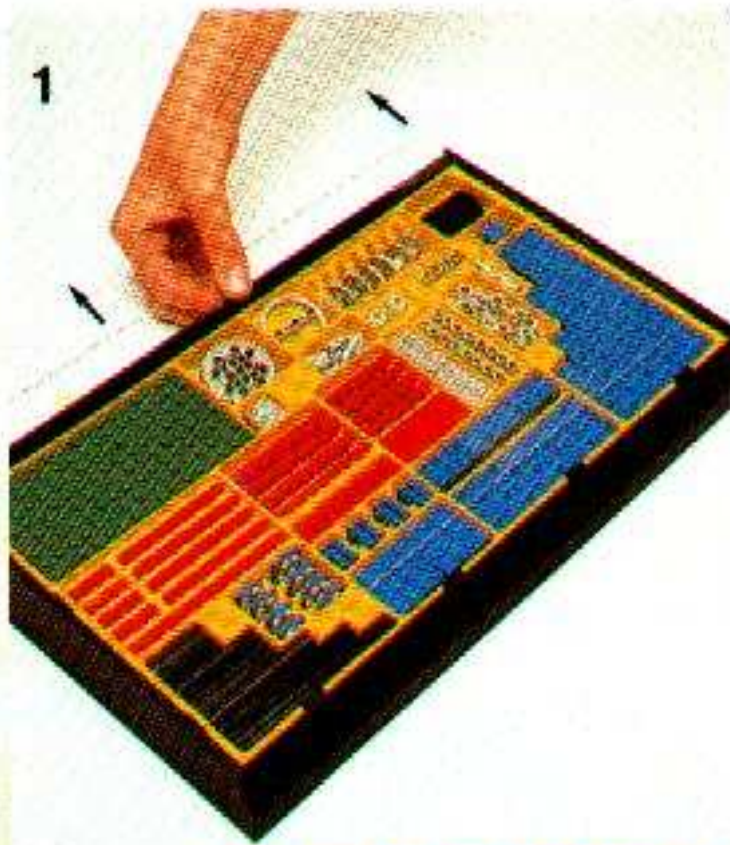



1031

2

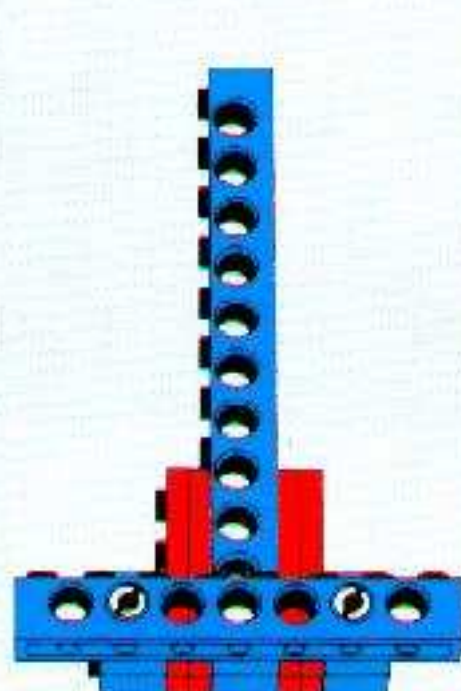
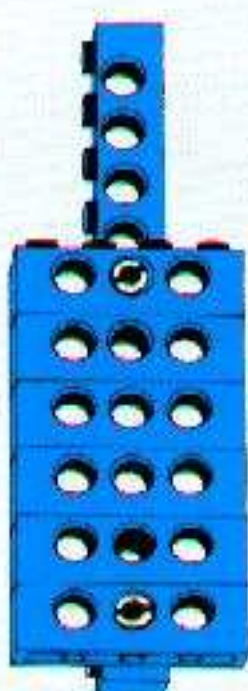
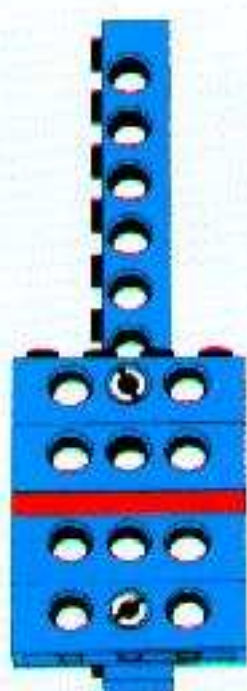
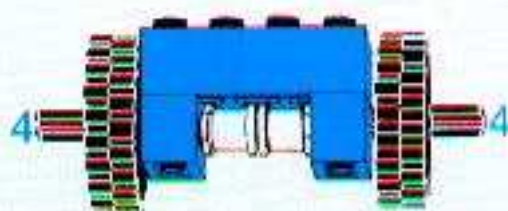
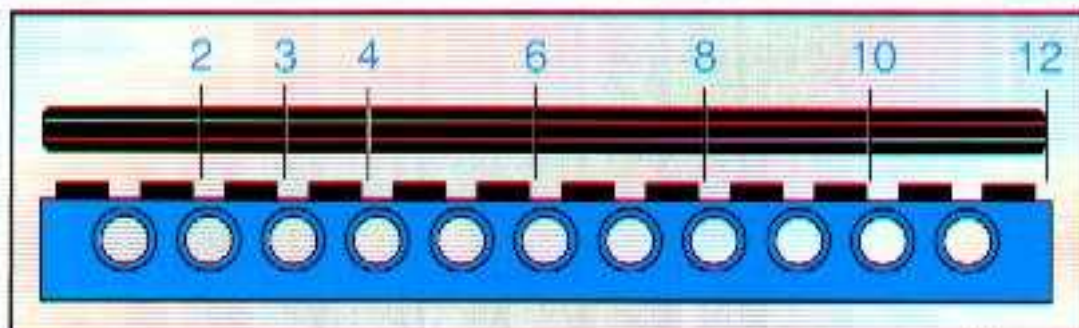

 **dacta**

Technic

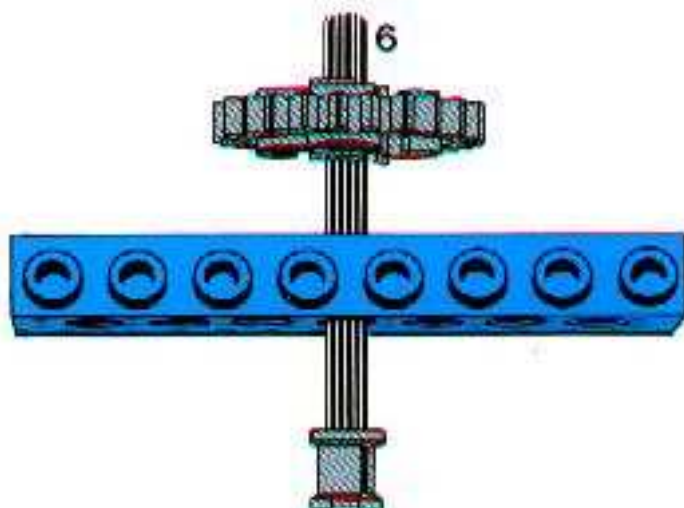
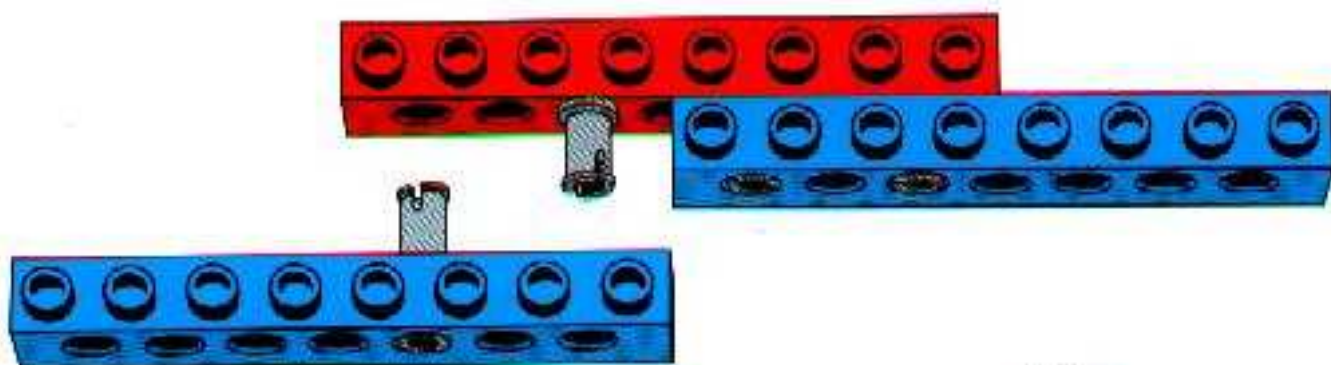
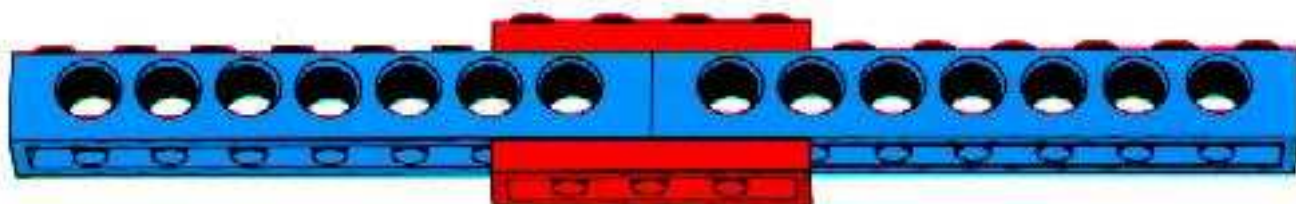
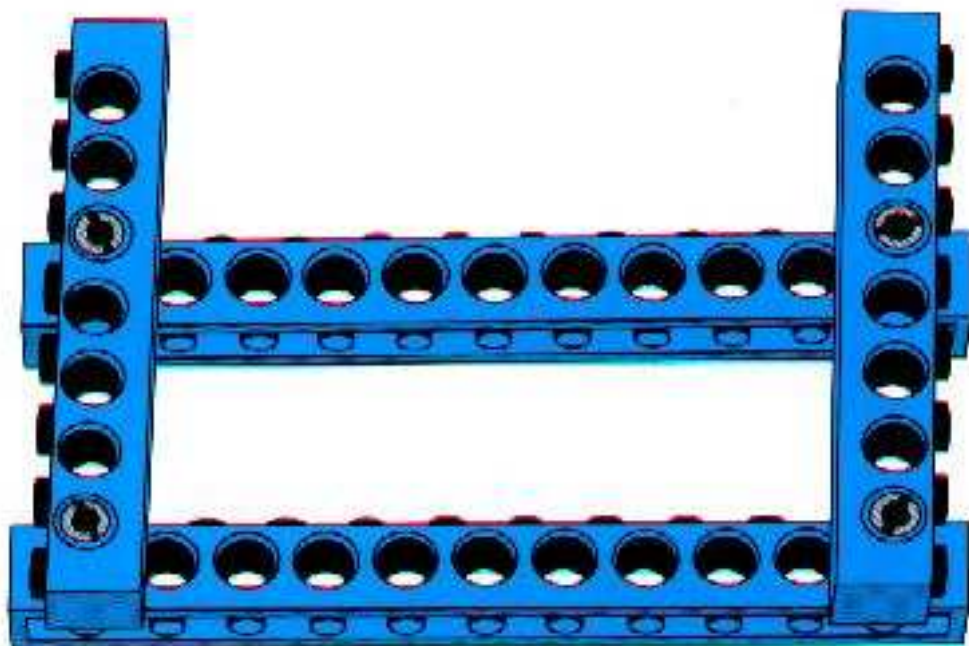
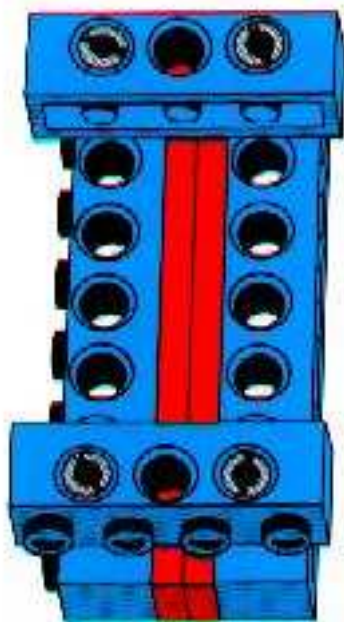

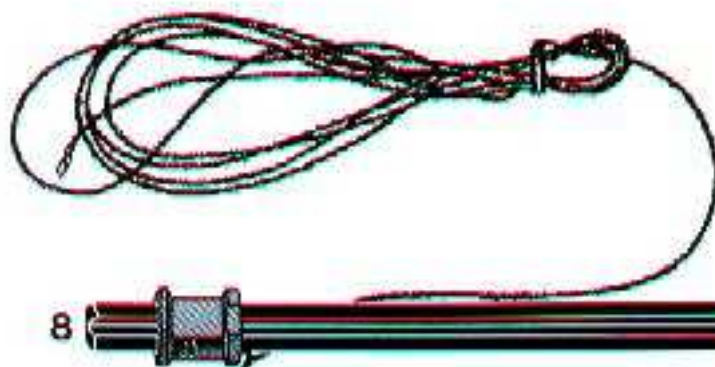
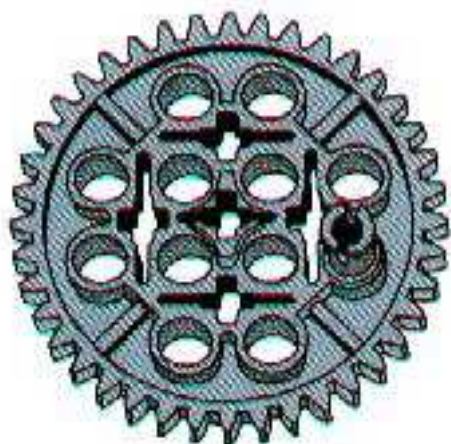
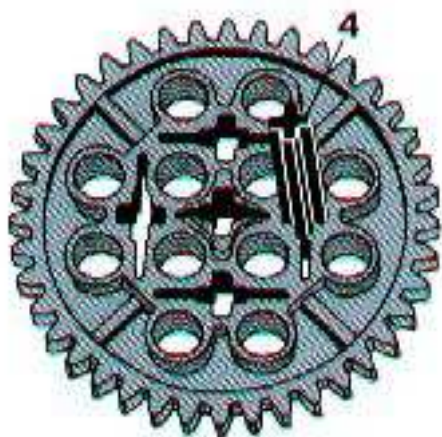
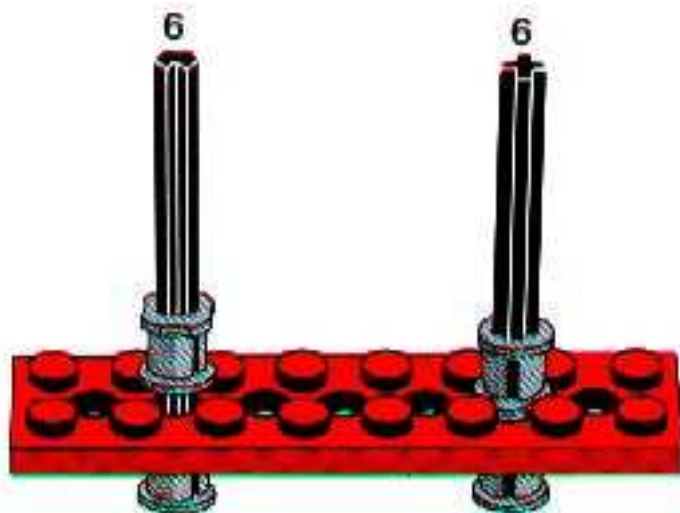
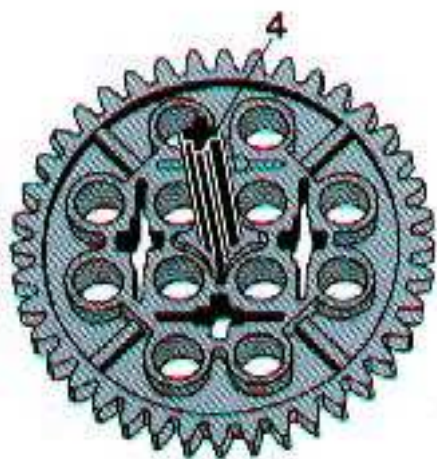
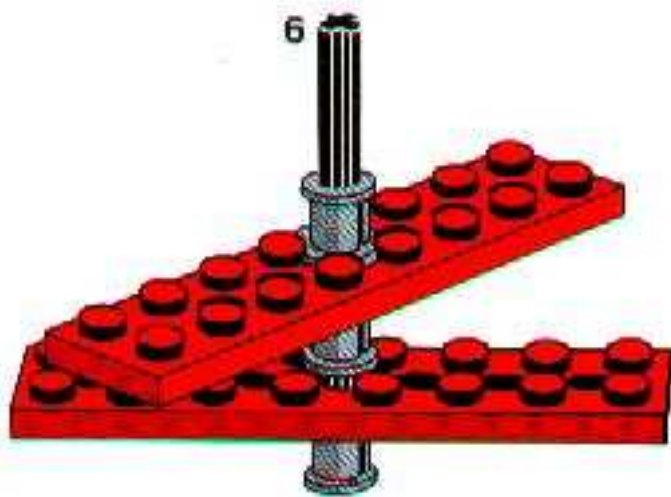
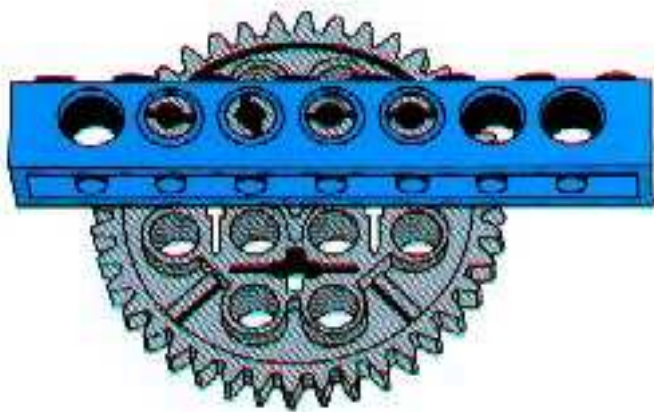

8

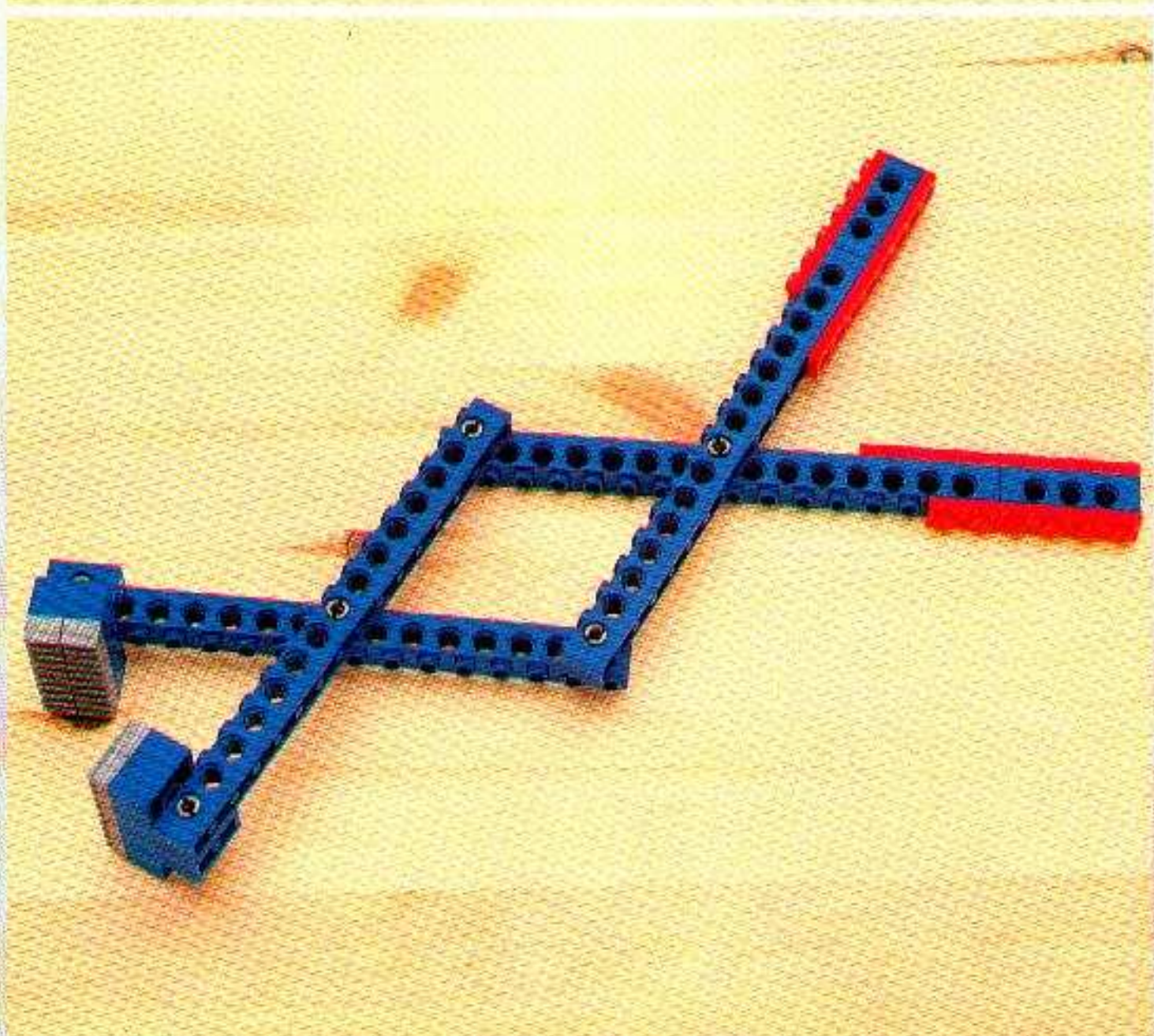
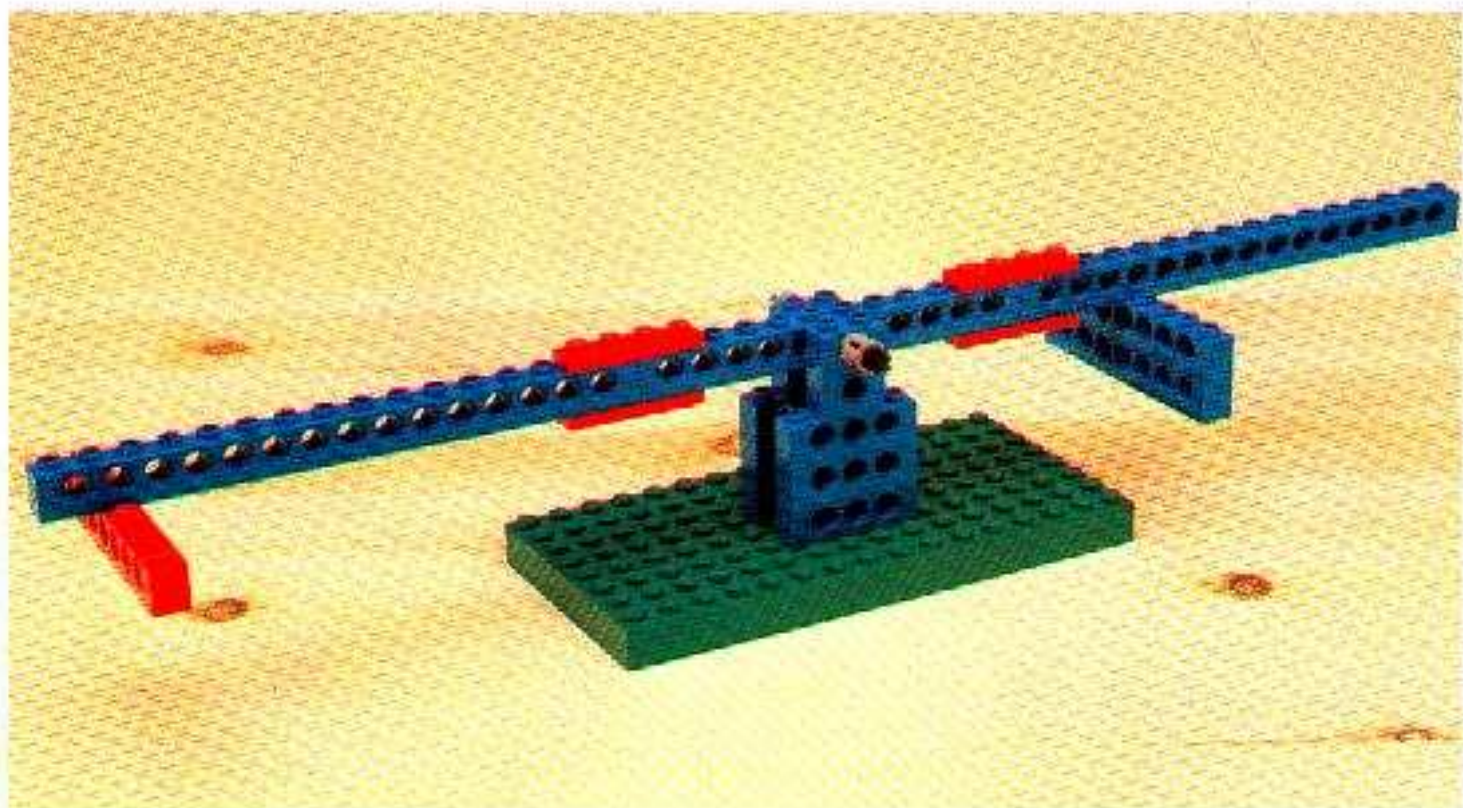



1031

3

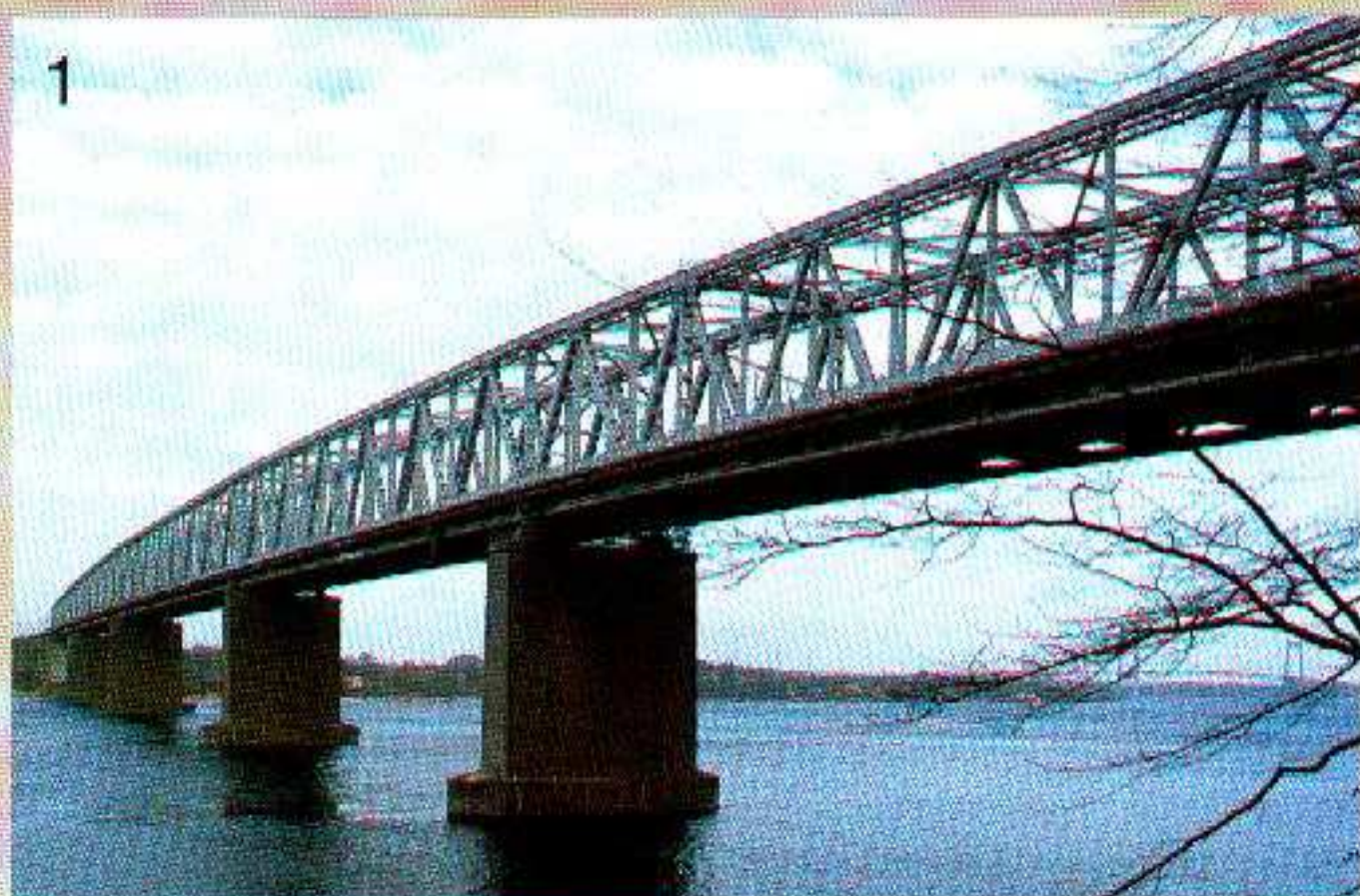

LEGO dacta

Technic

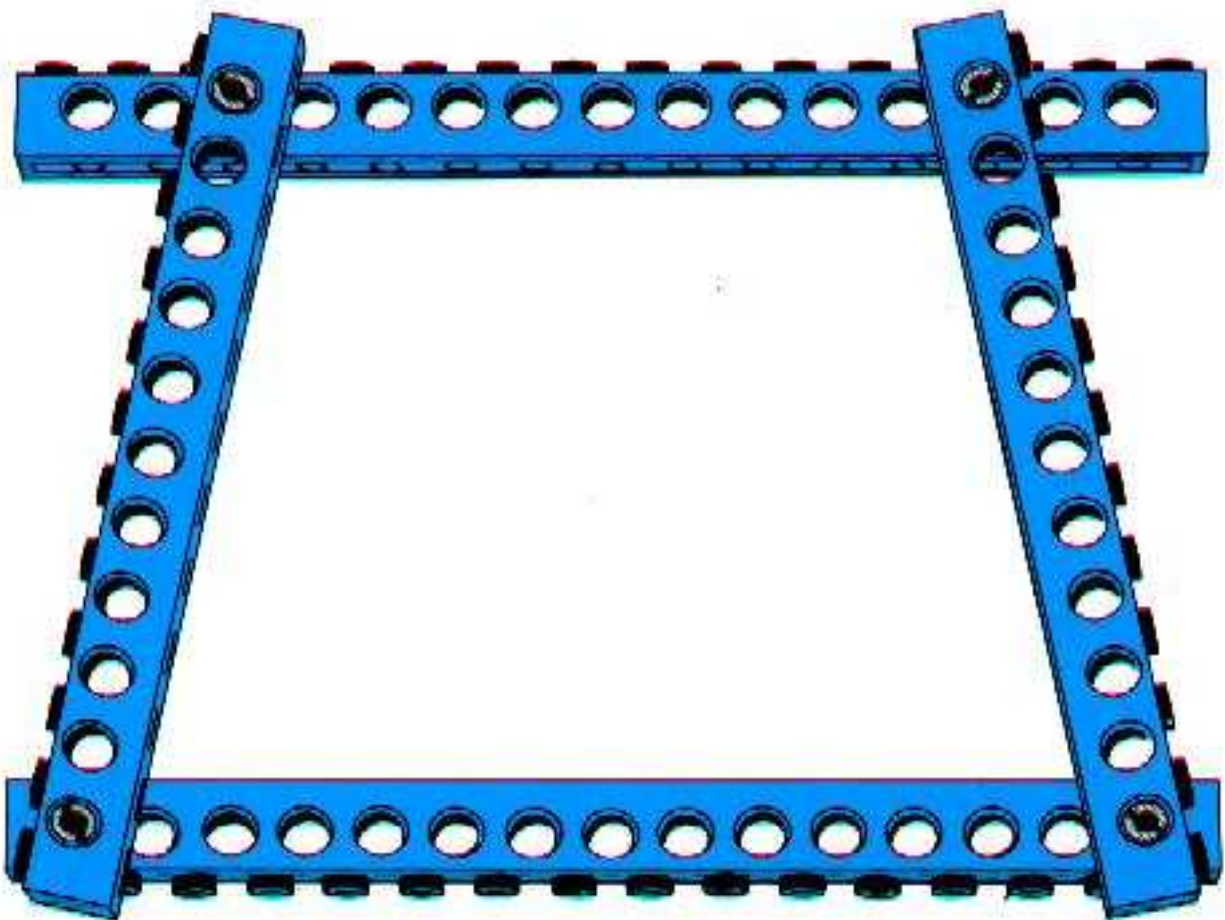
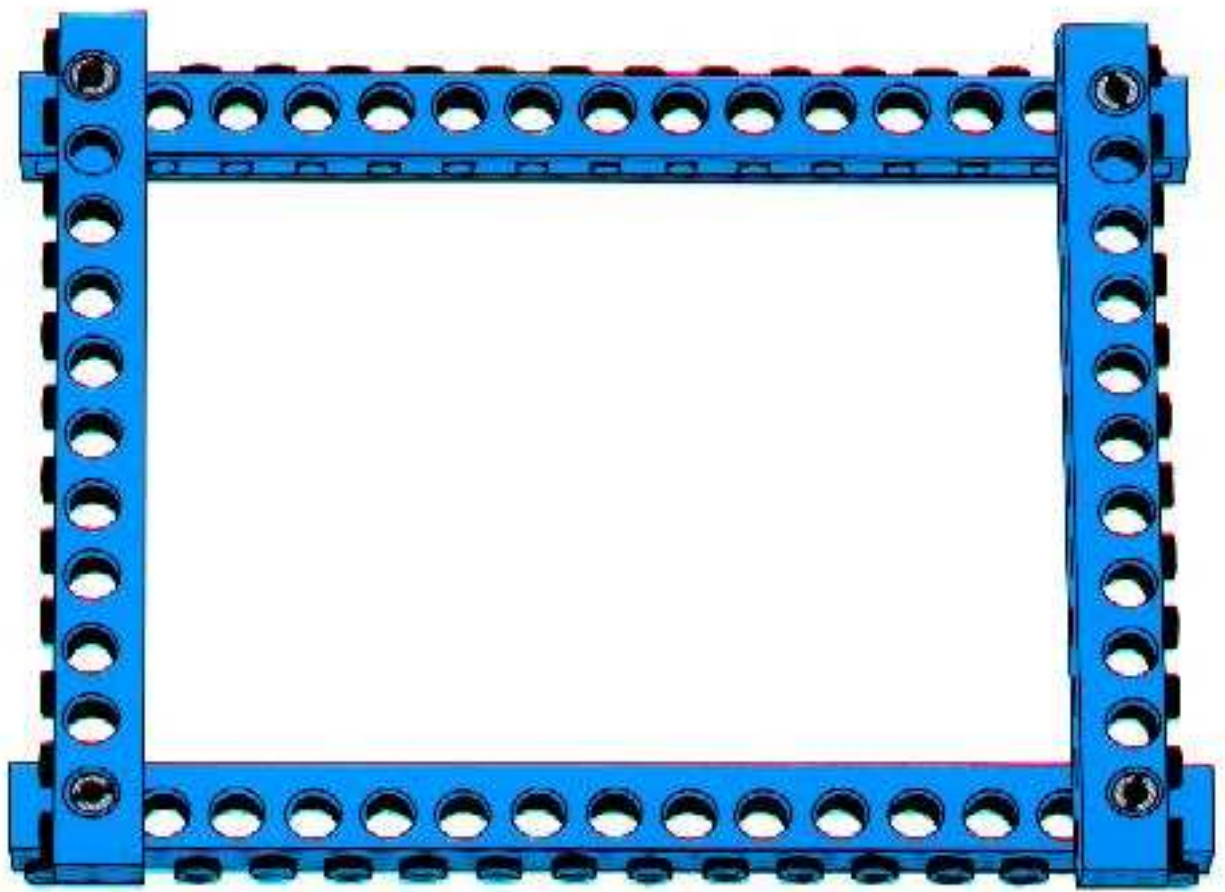

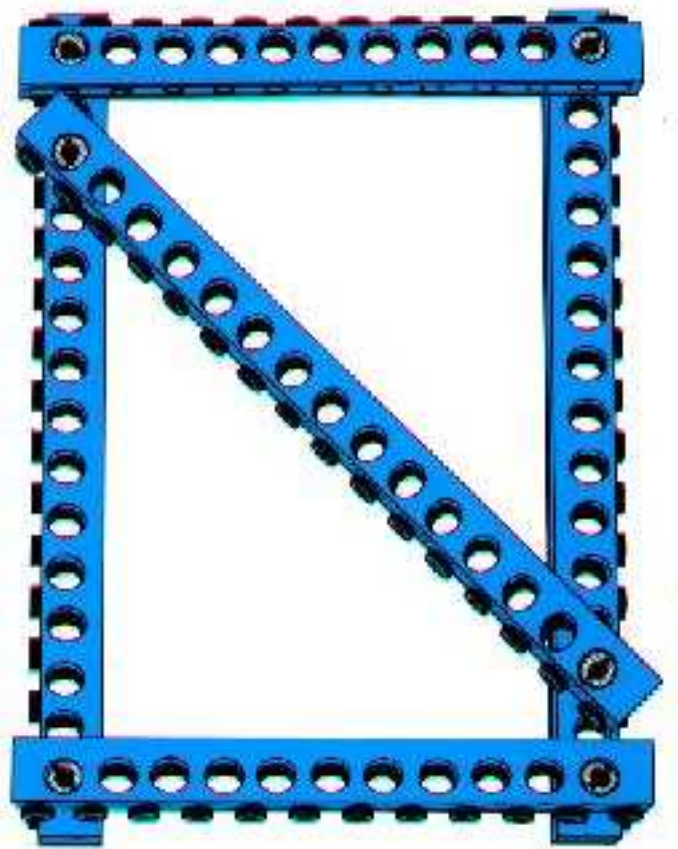
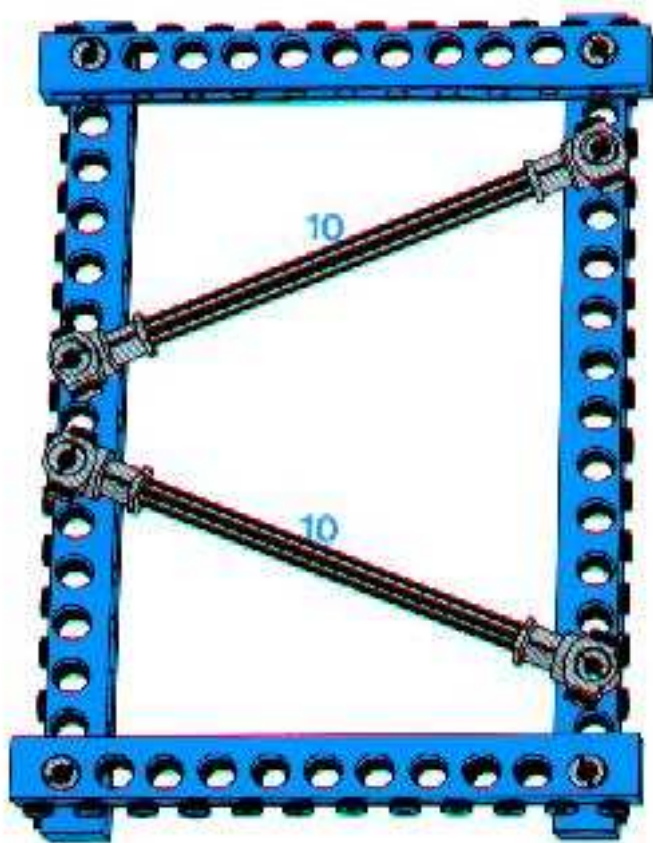
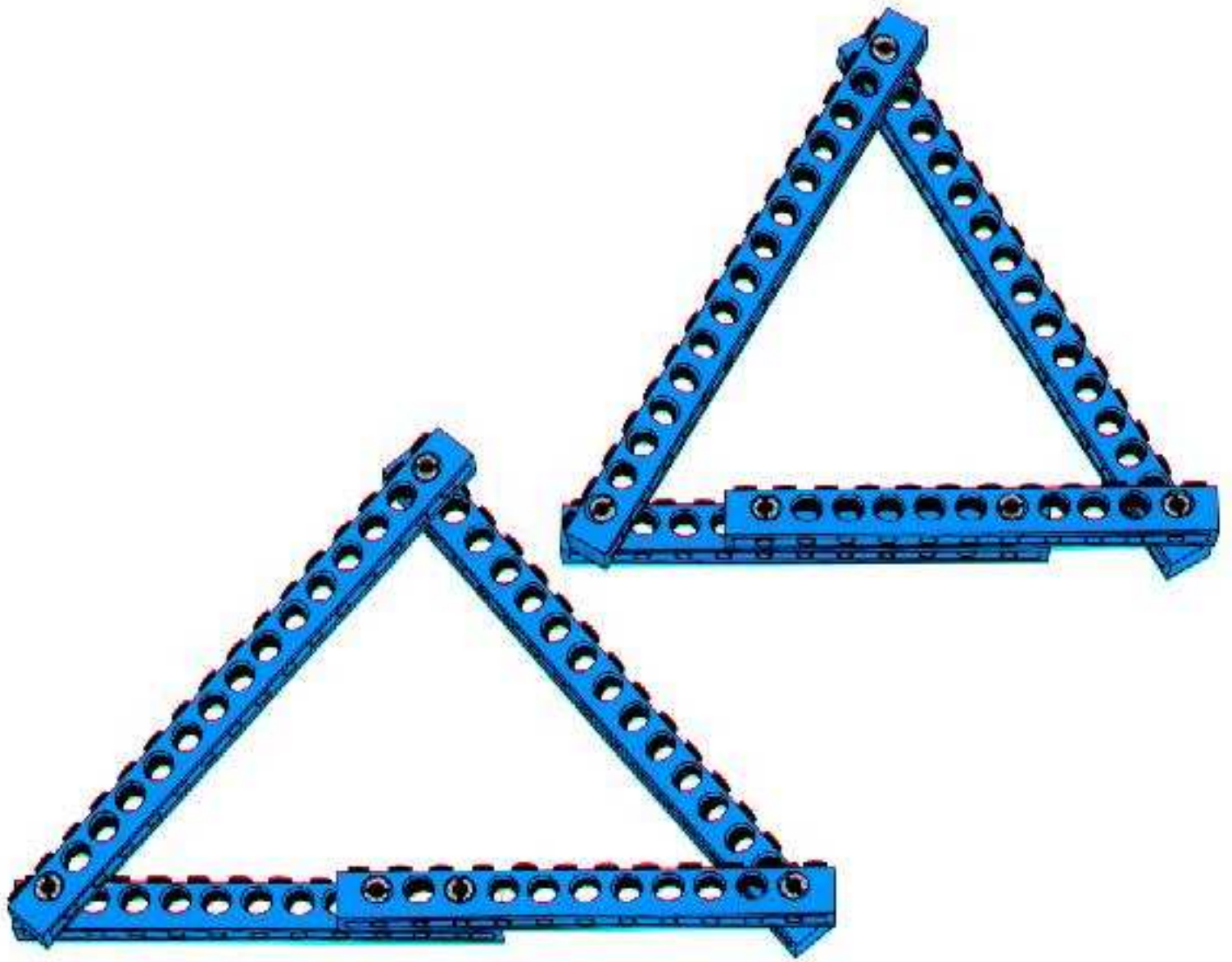

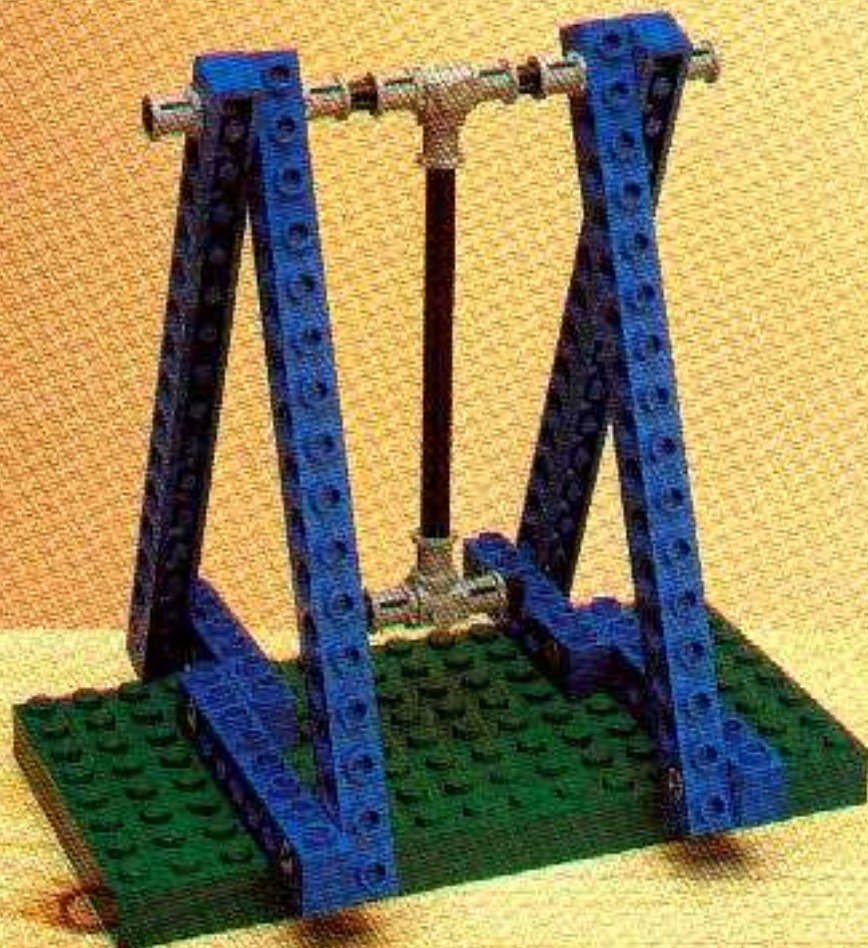
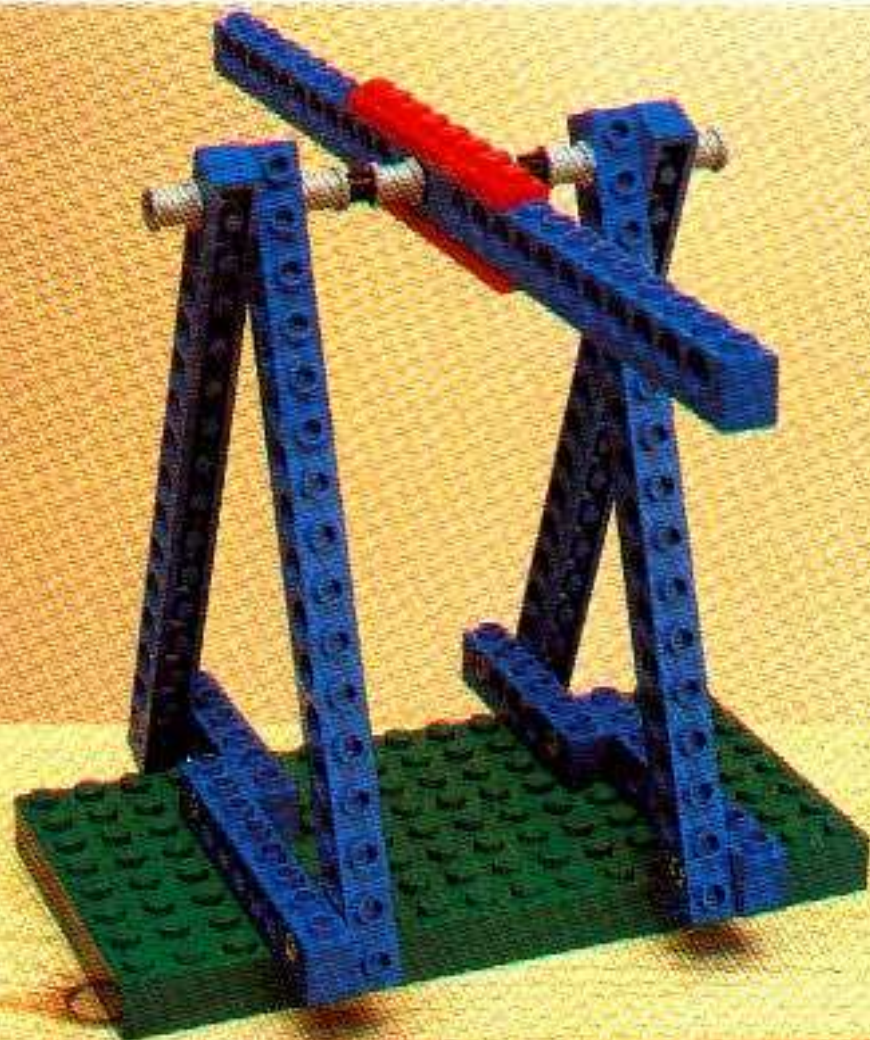



1031

4



2



LEGO dacta

Technic

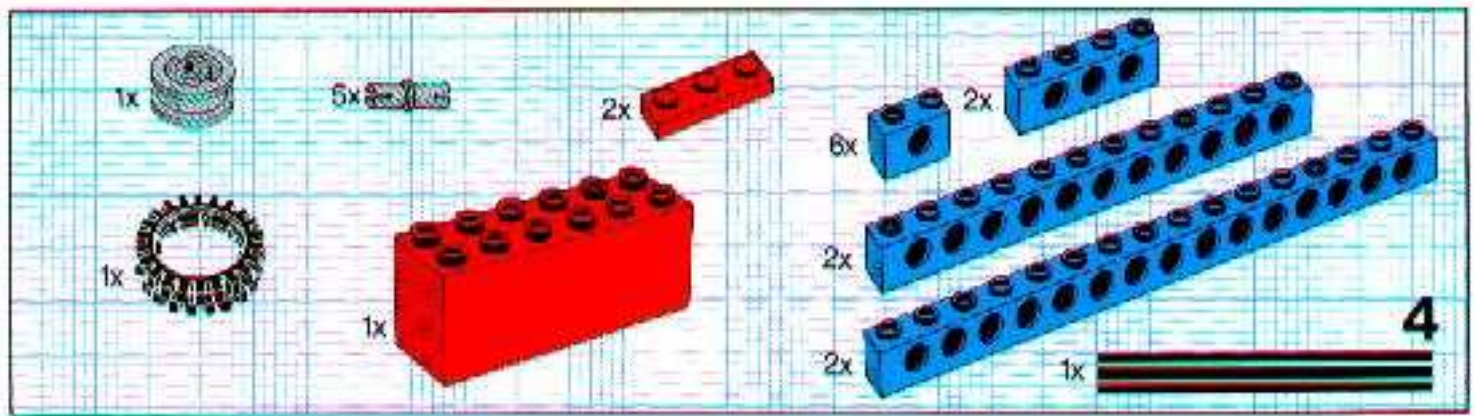

1

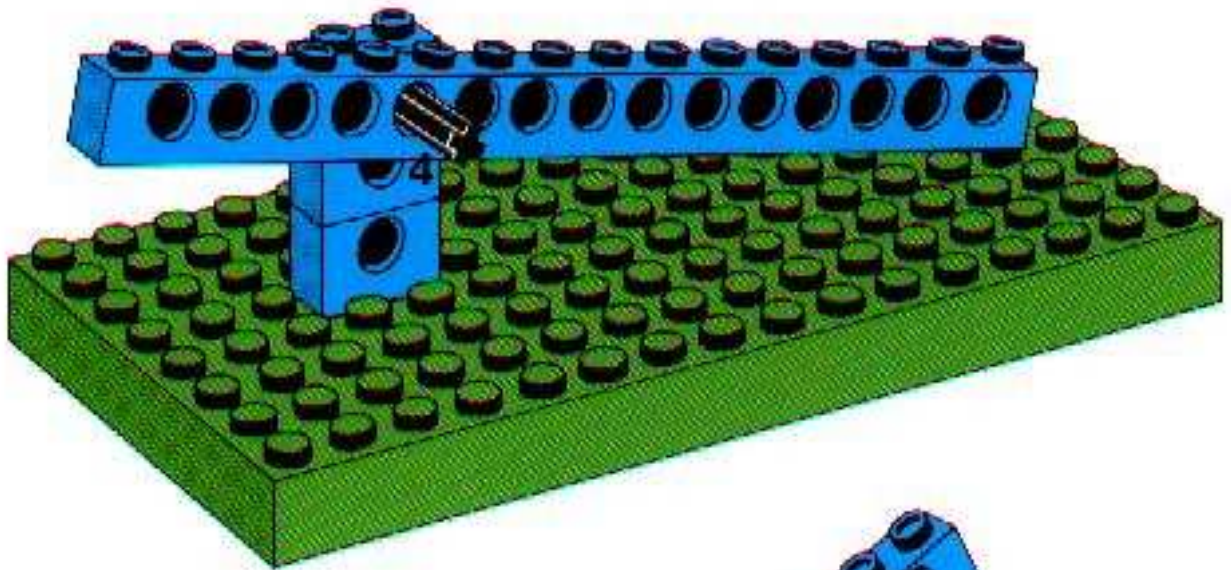

2

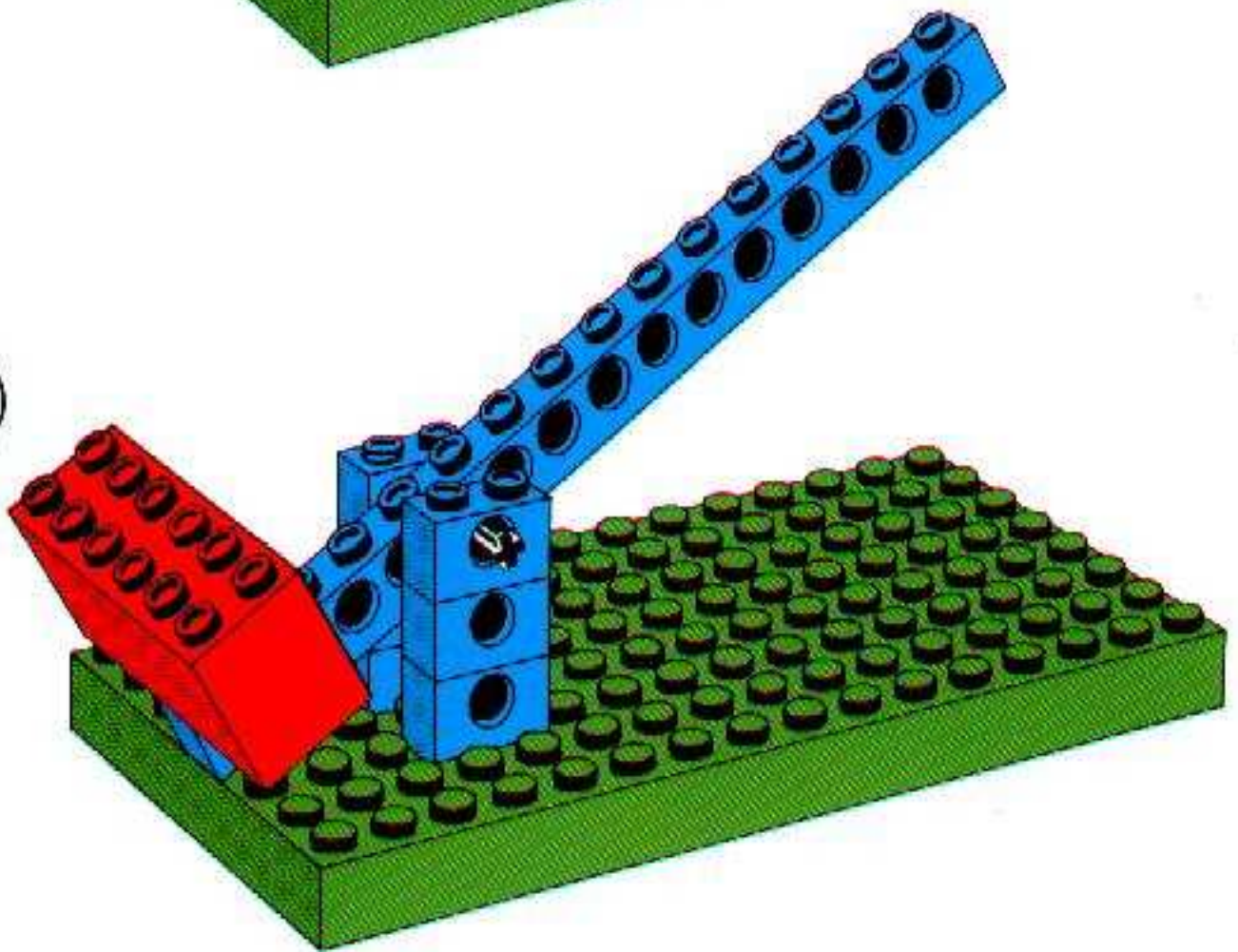

1

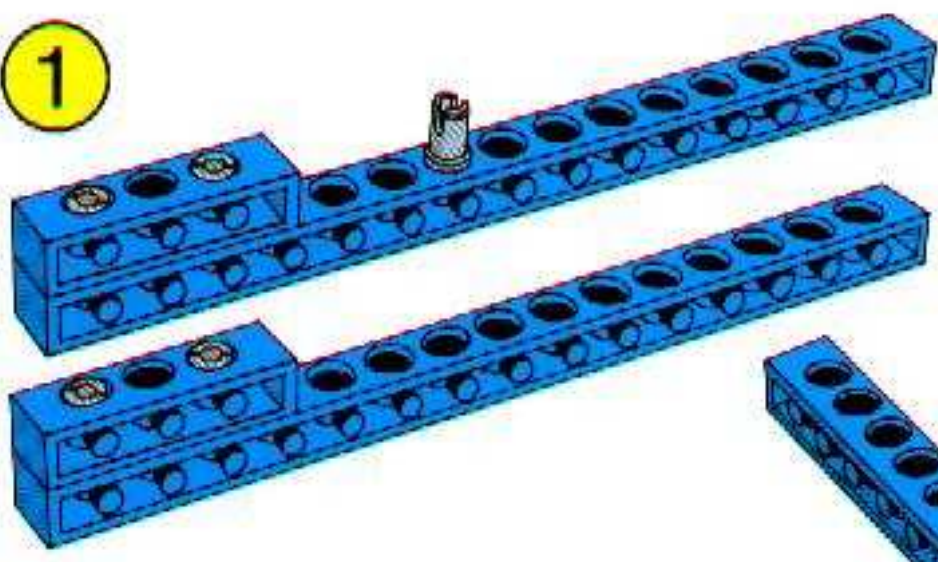

2

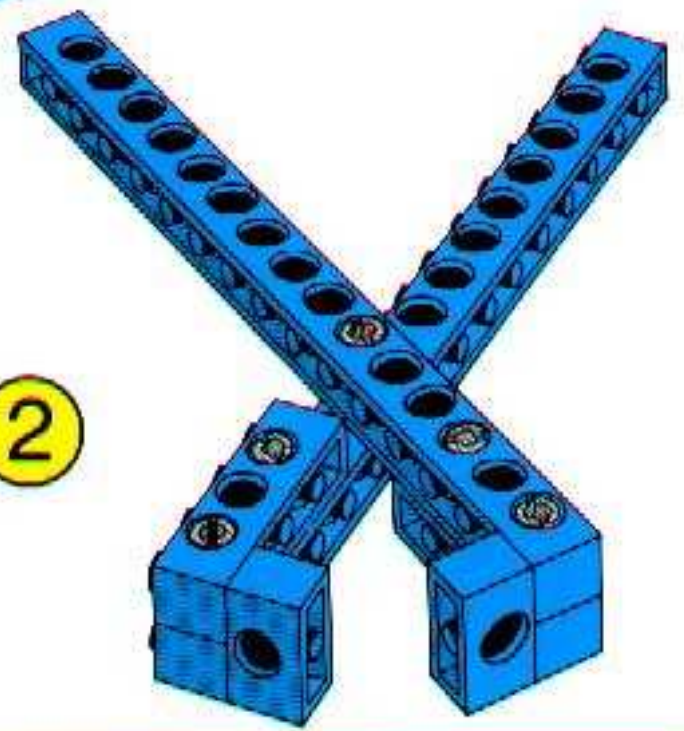

1

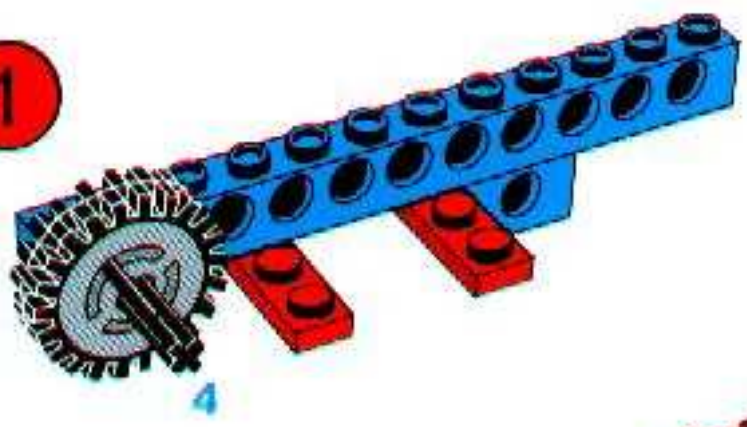

2

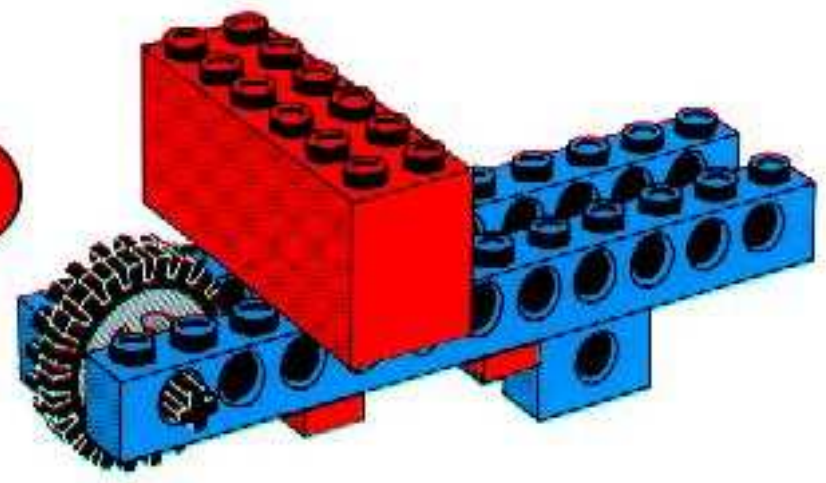

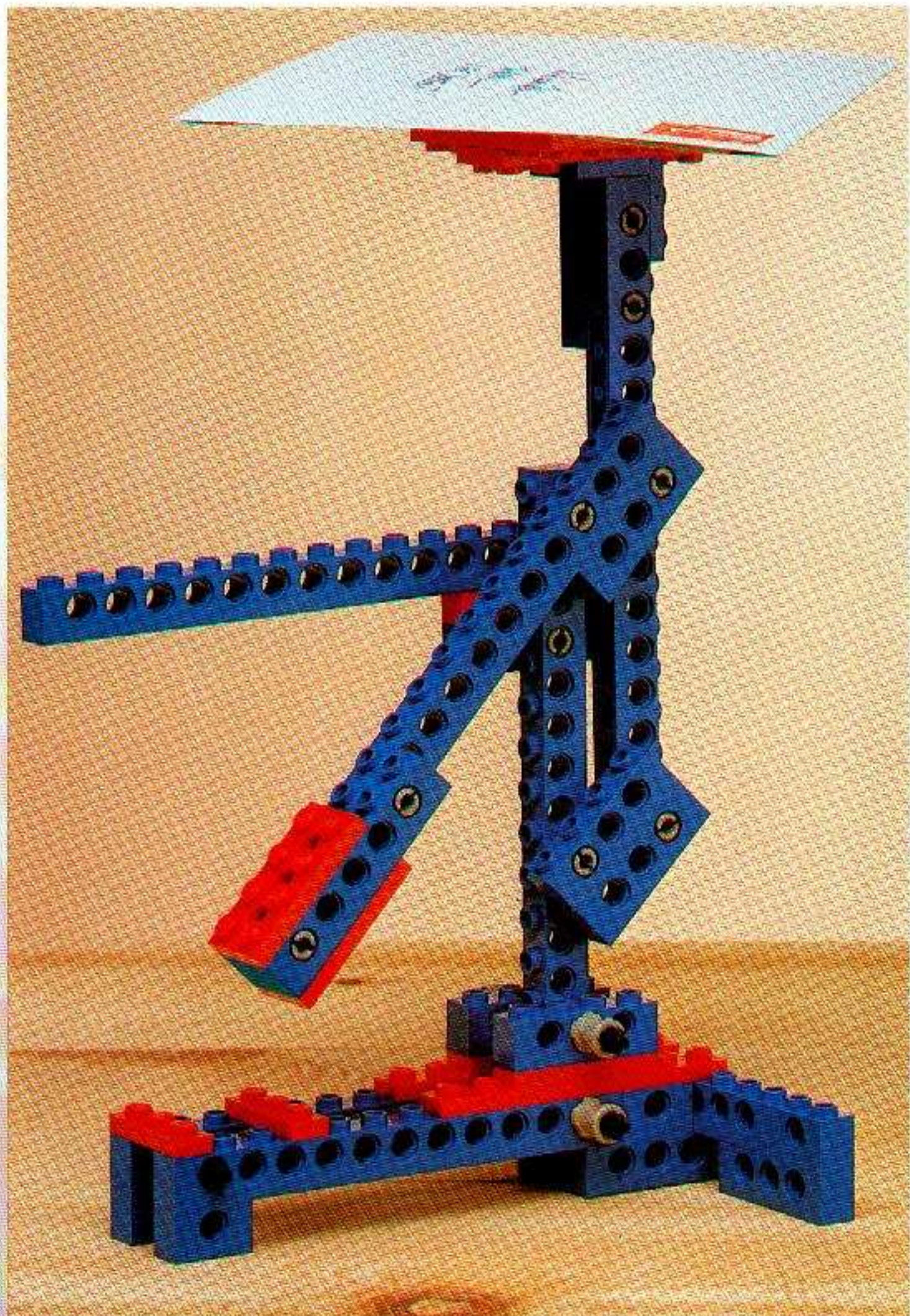



1031

5

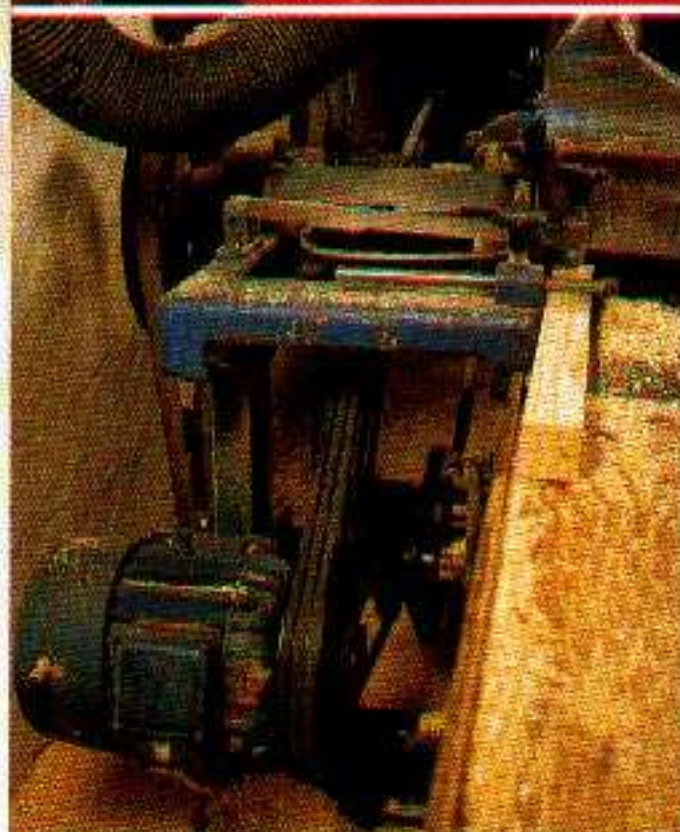
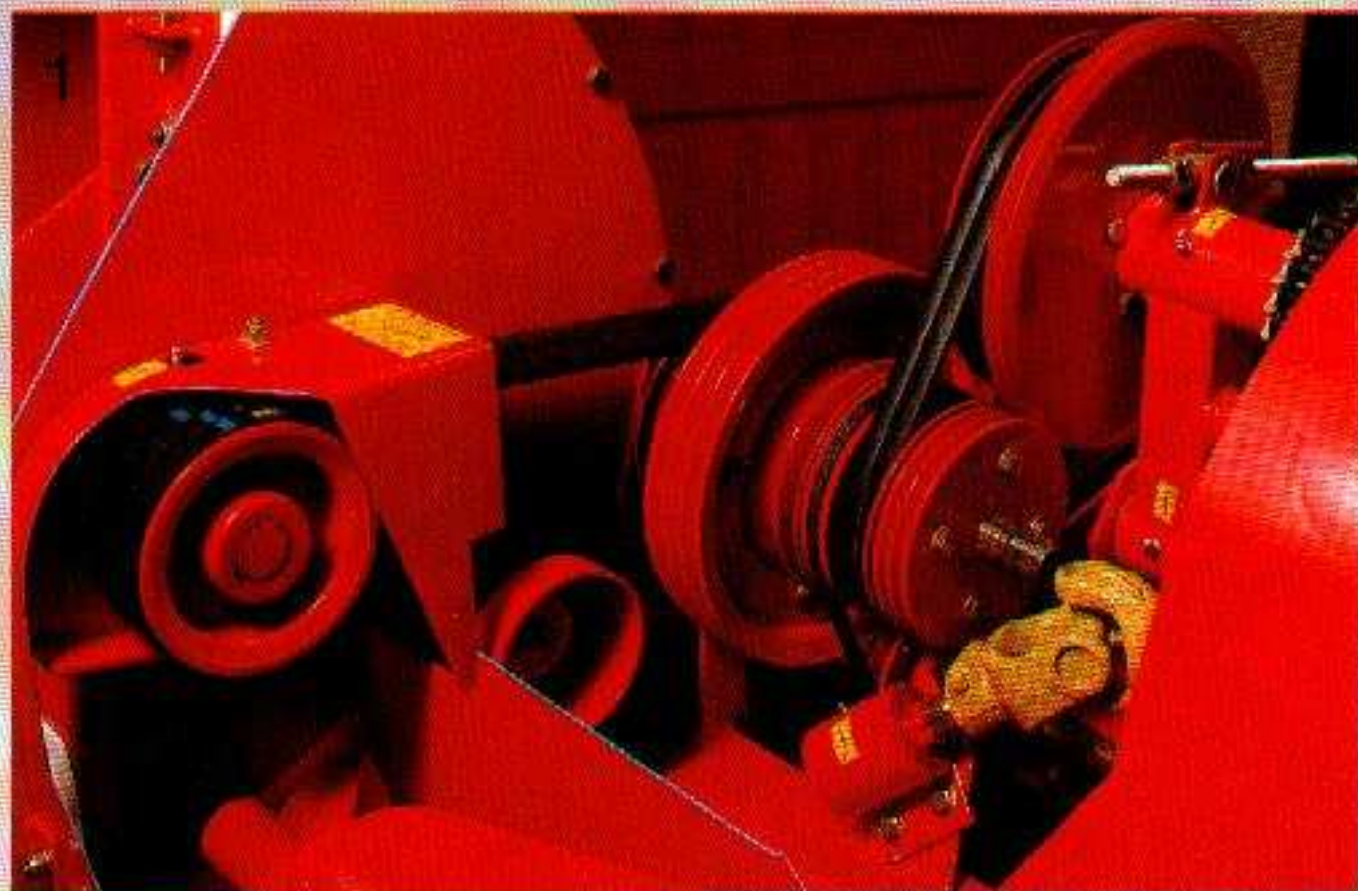

LEGO dacta

Technic

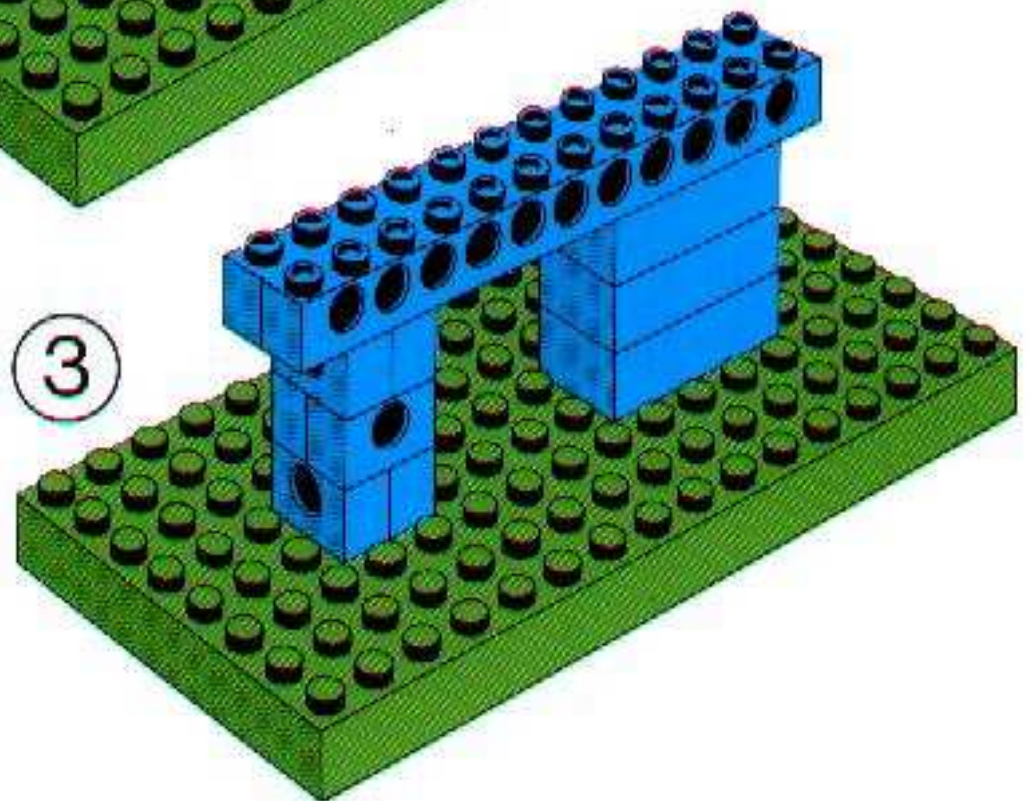
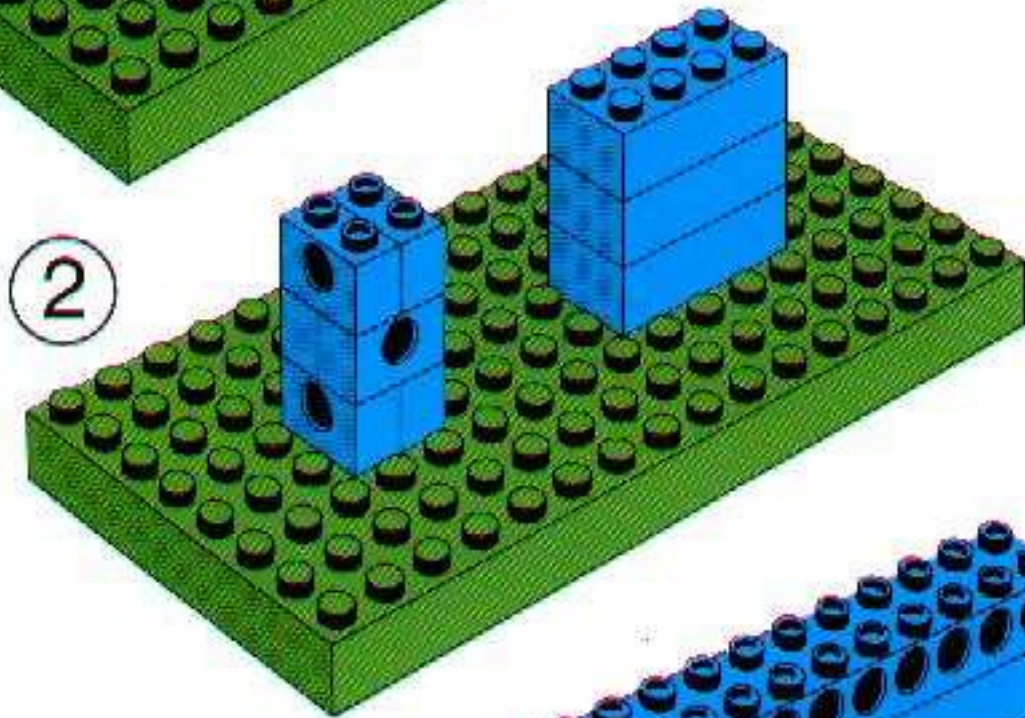
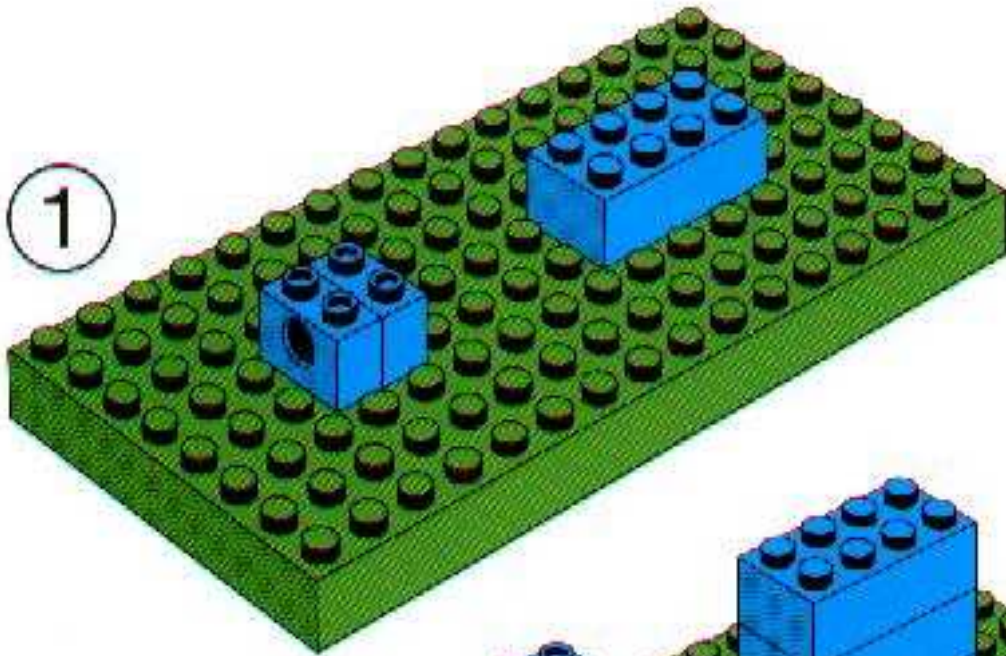
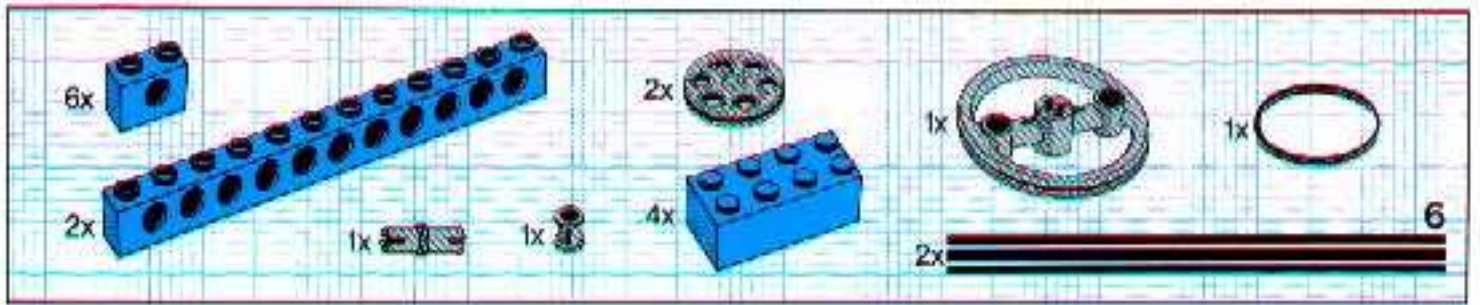

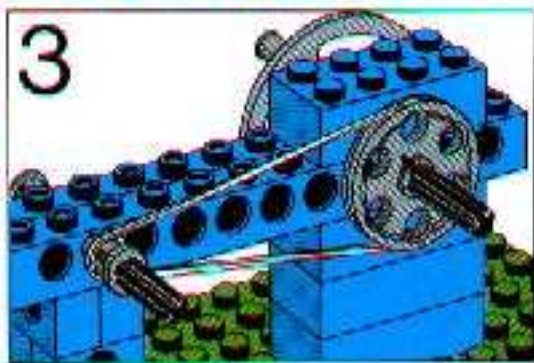
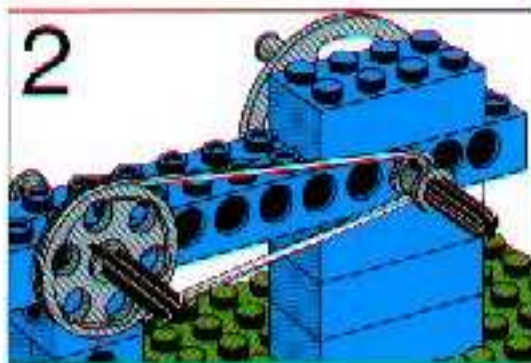
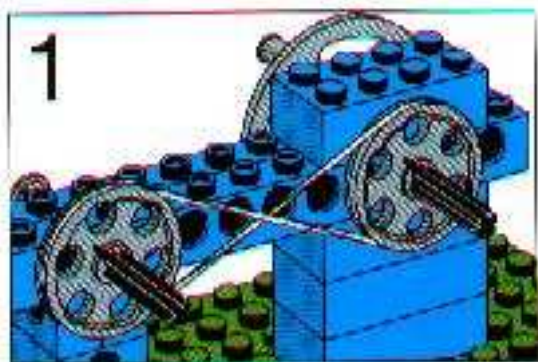
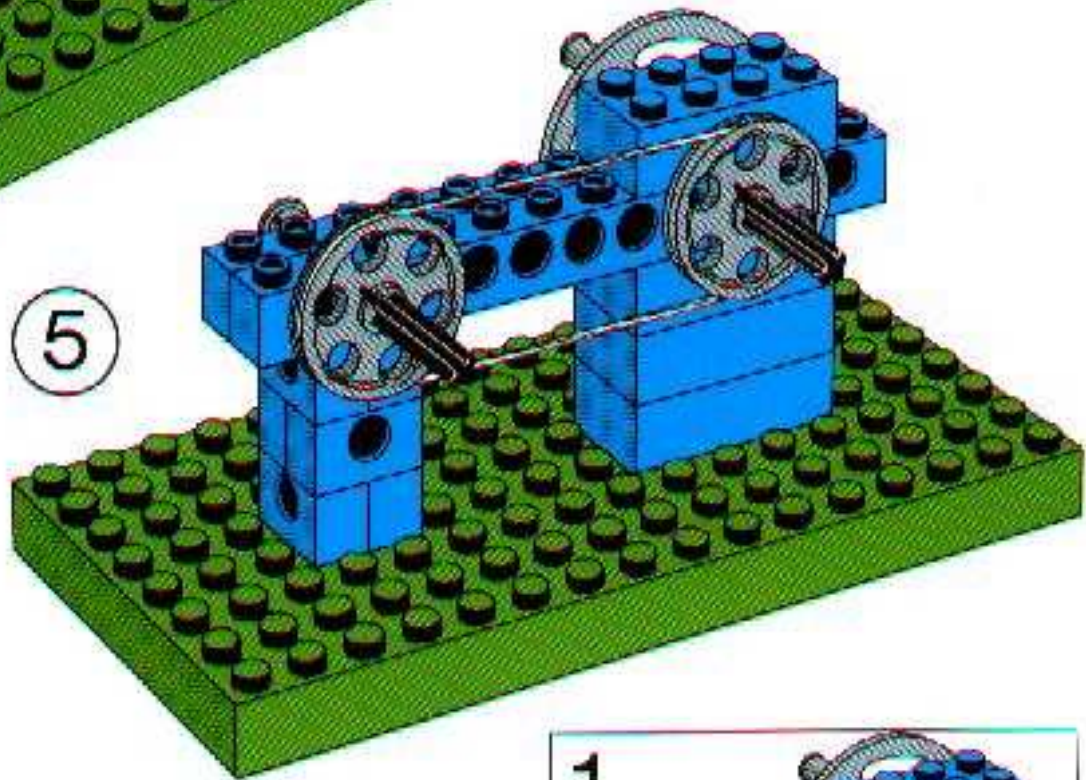
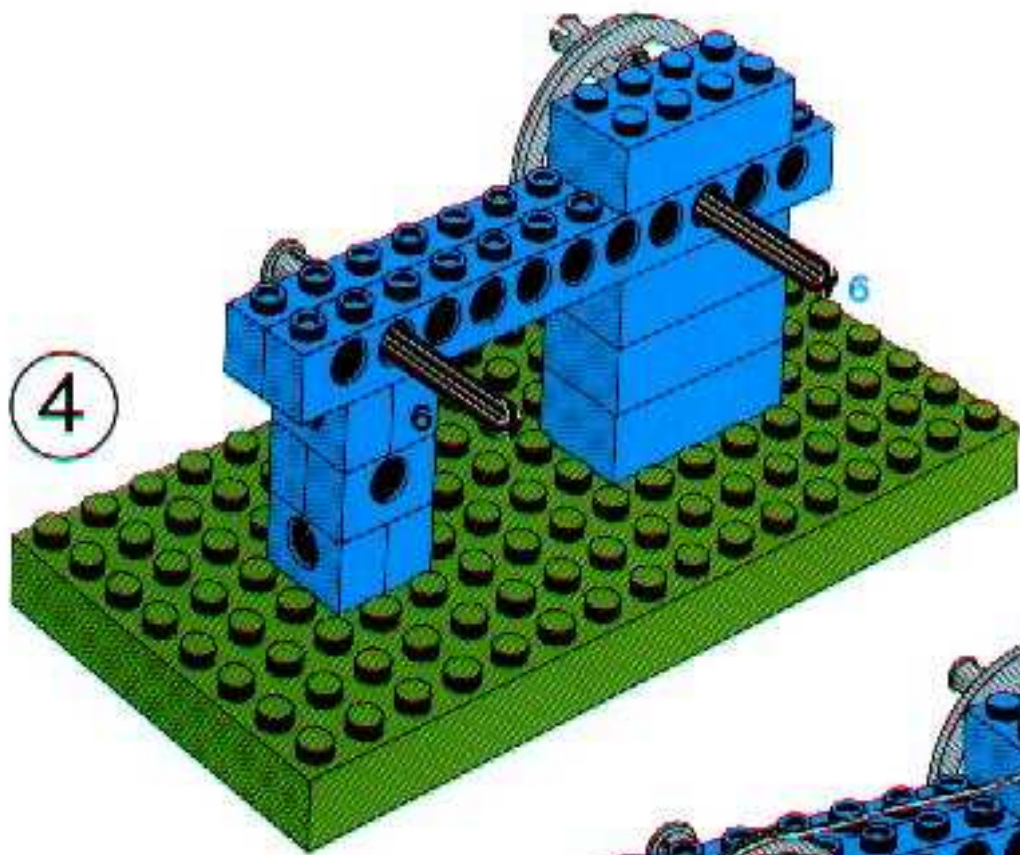

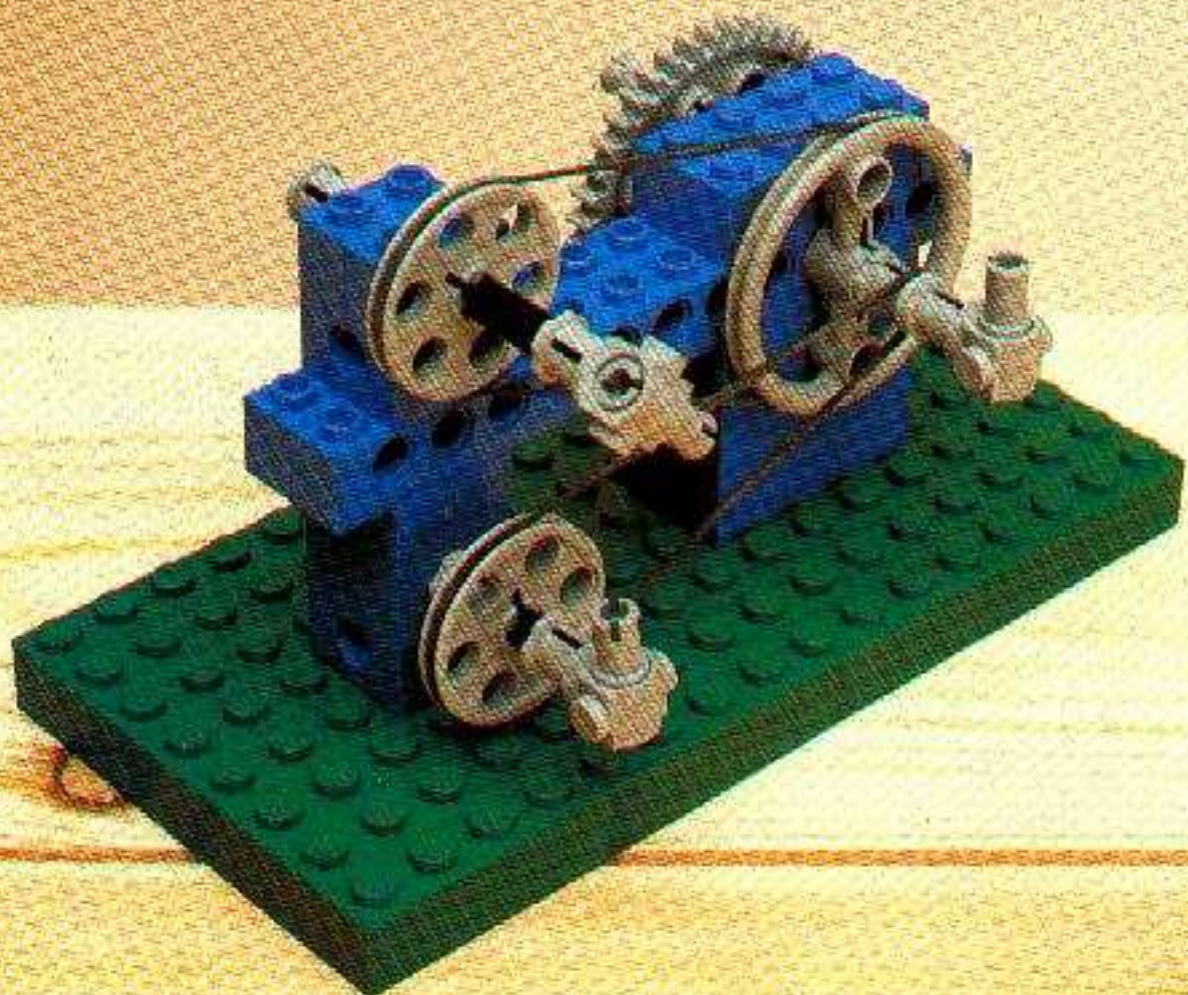
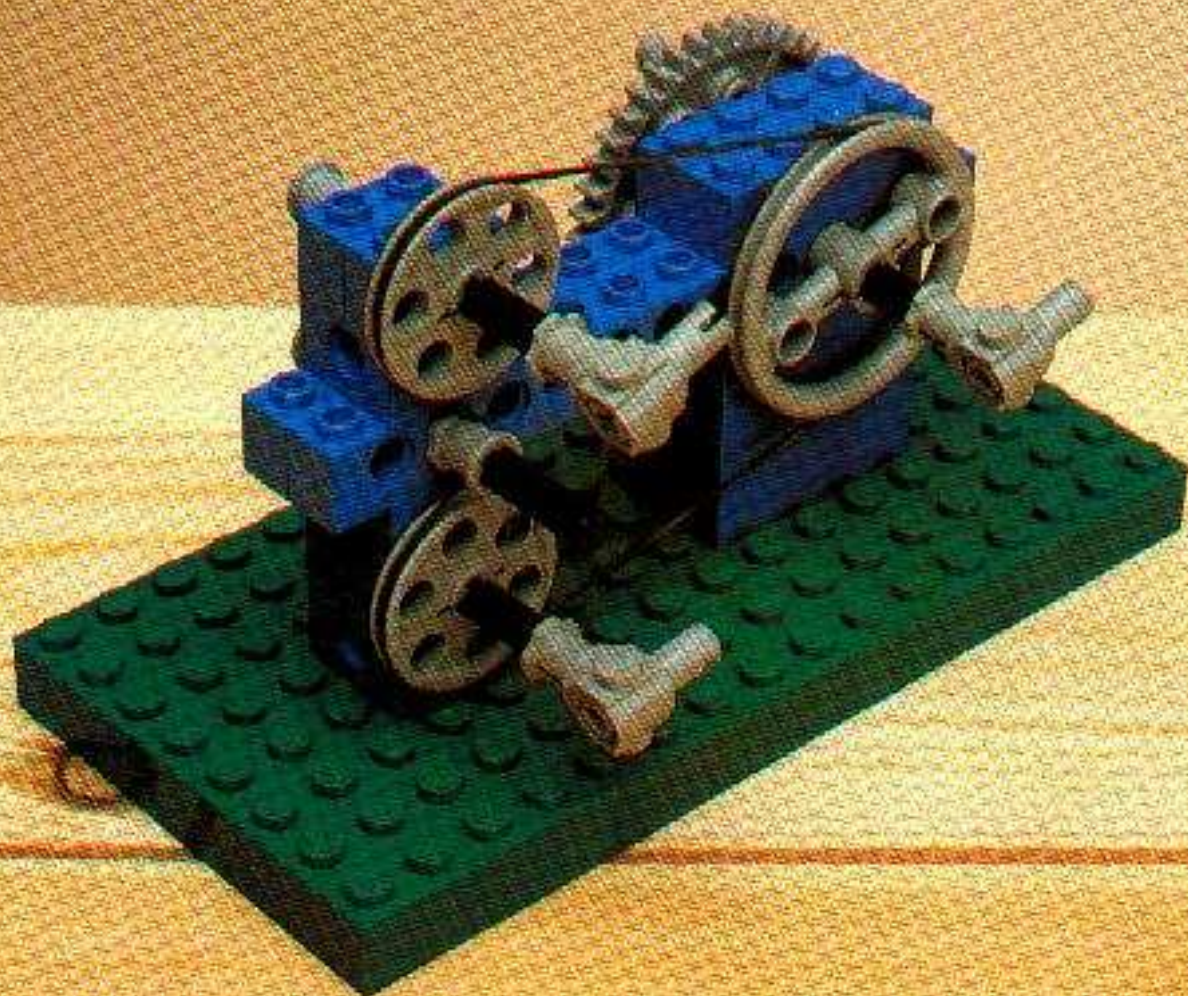

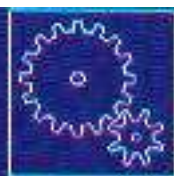

1031

6



LEGO dacta

Technic

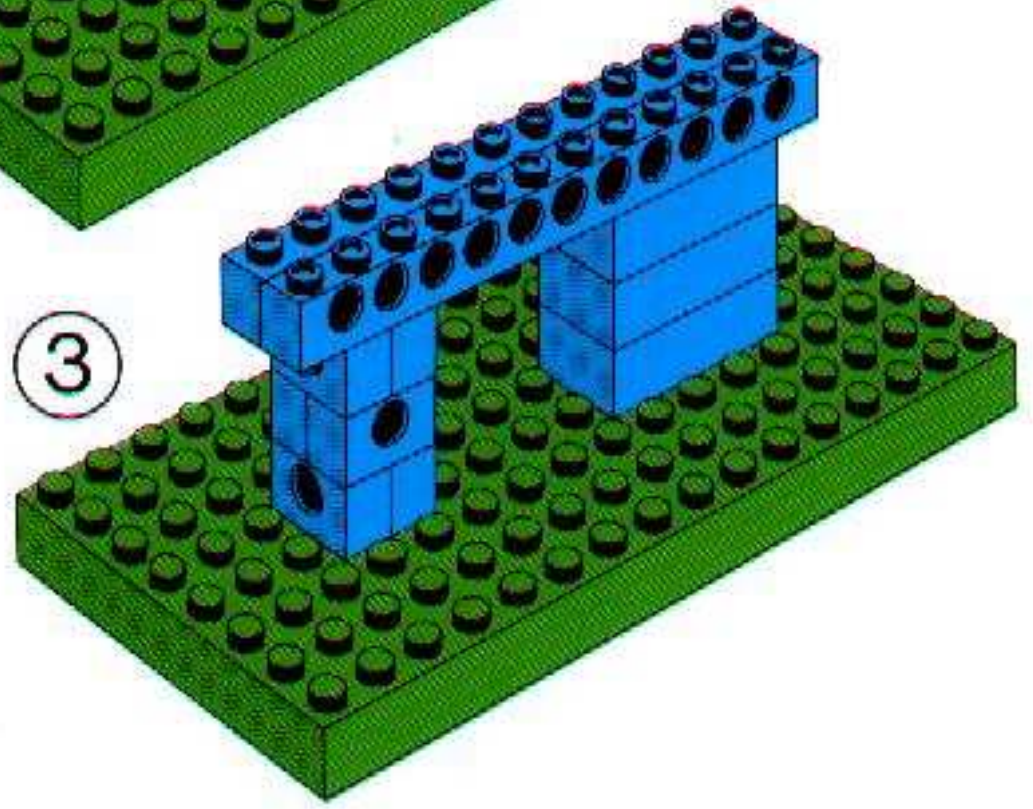
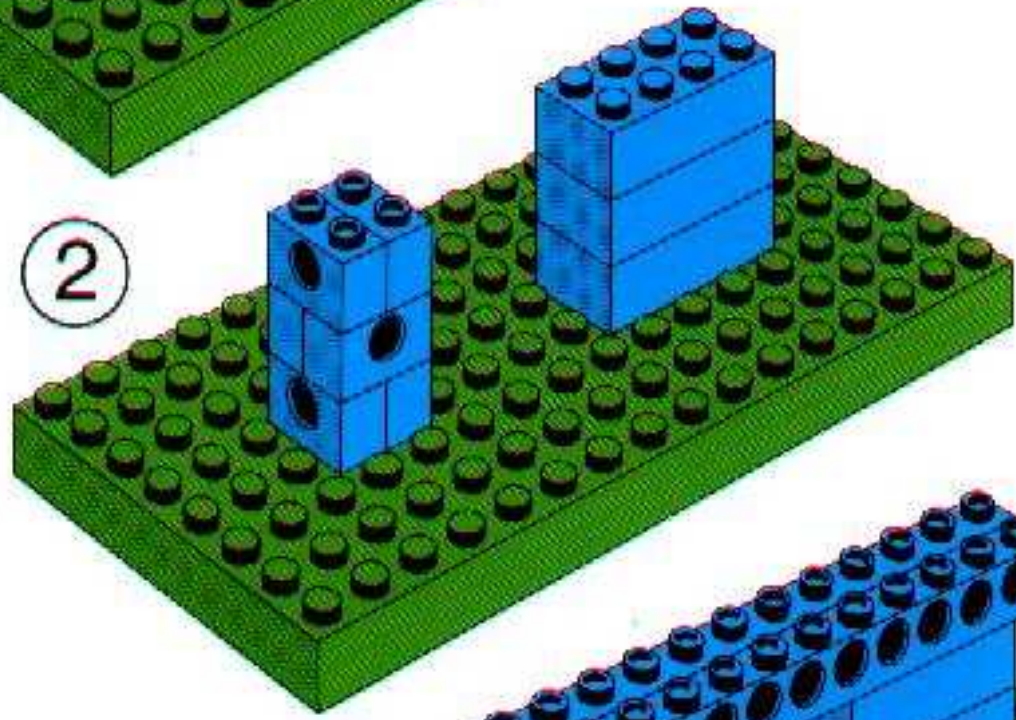
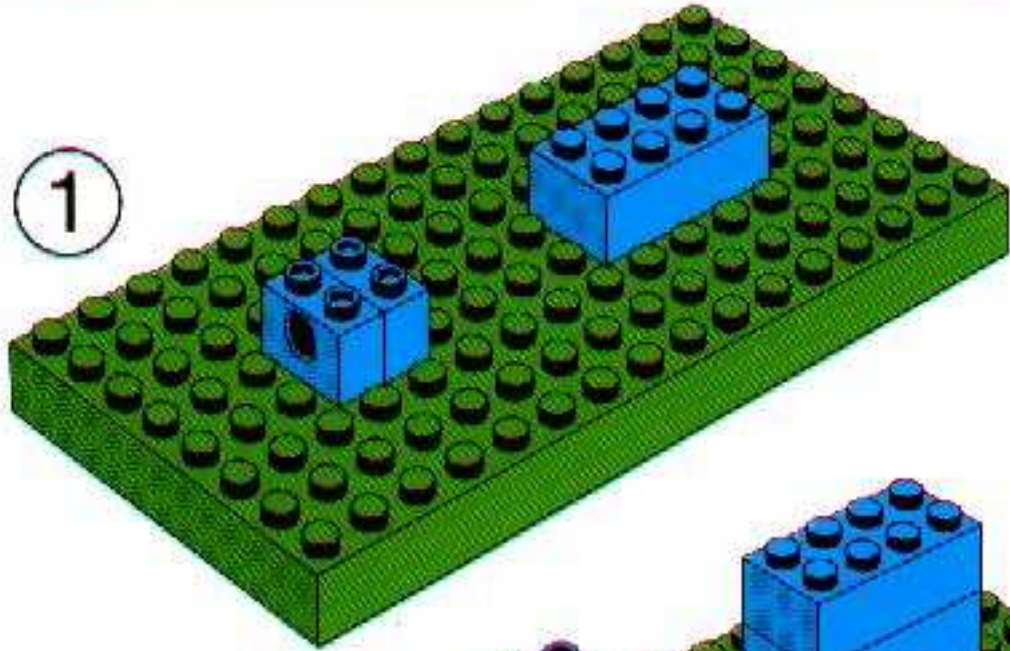
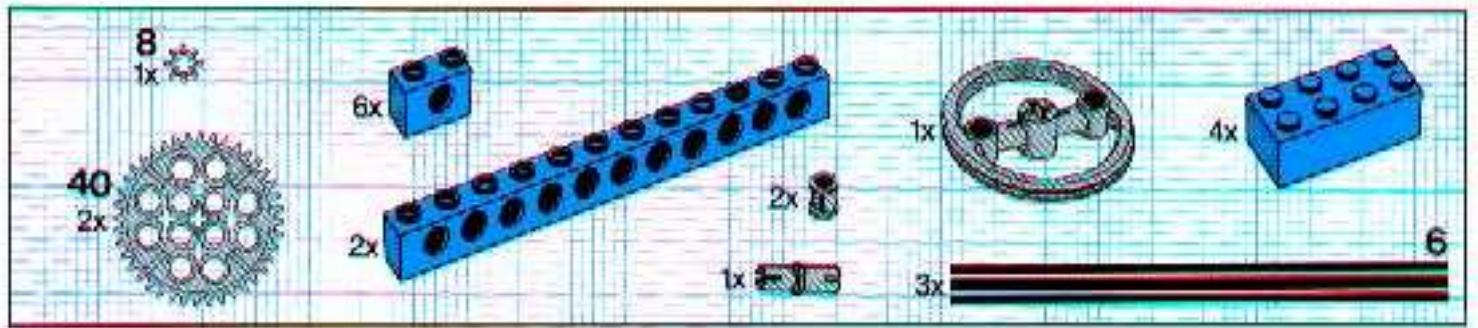

4

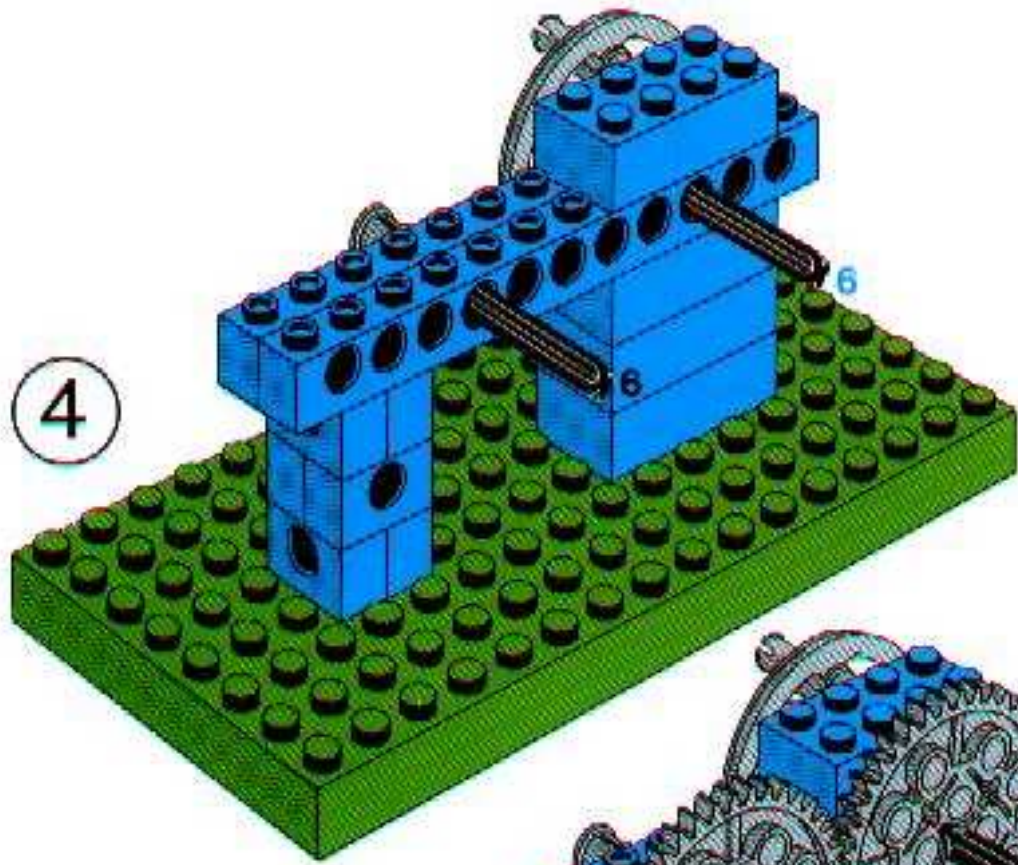

5

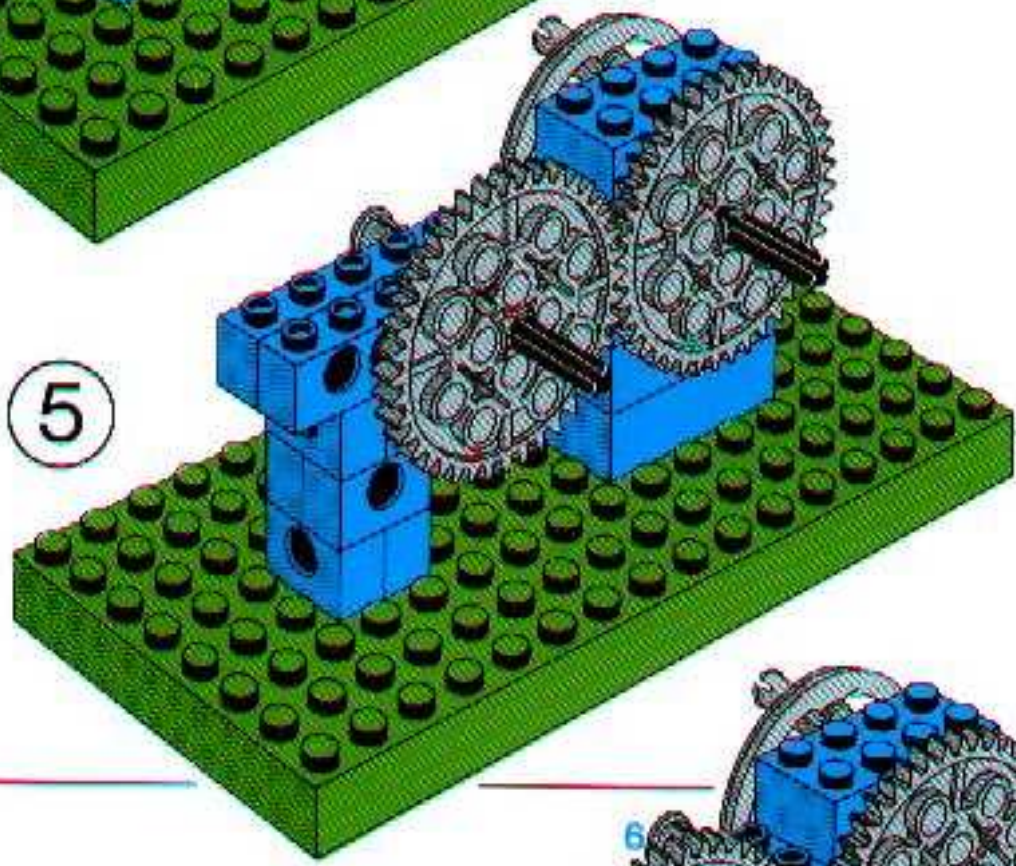

1

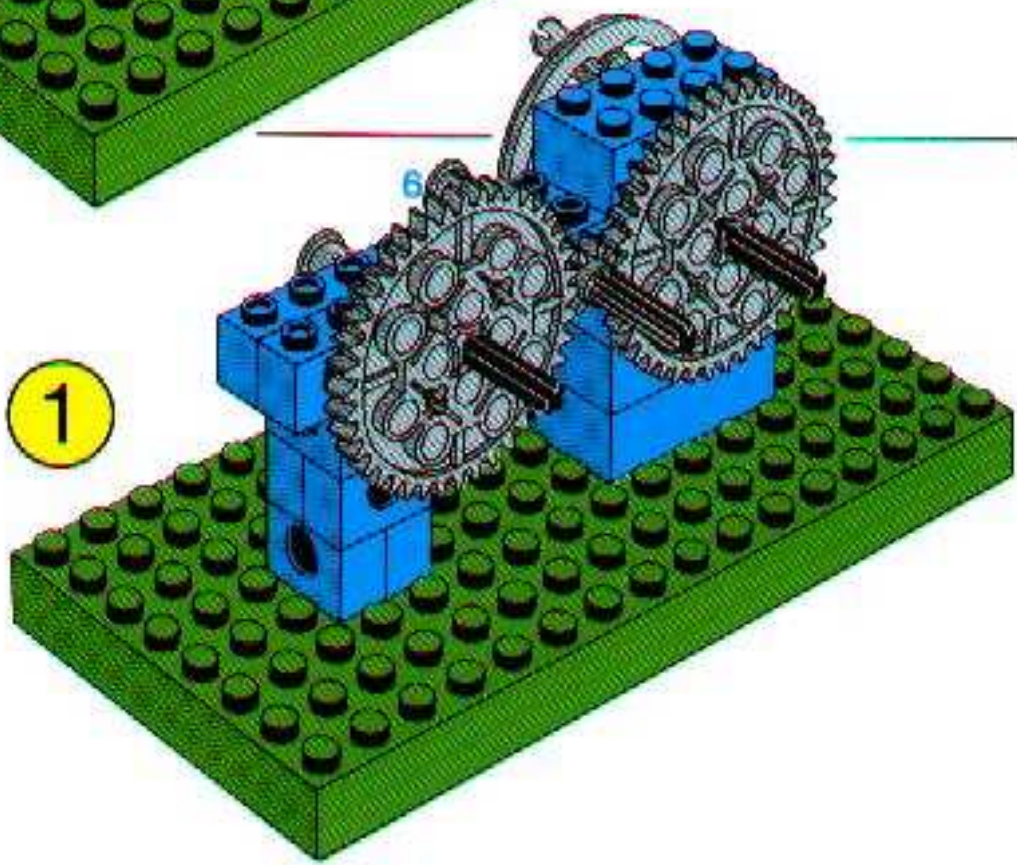

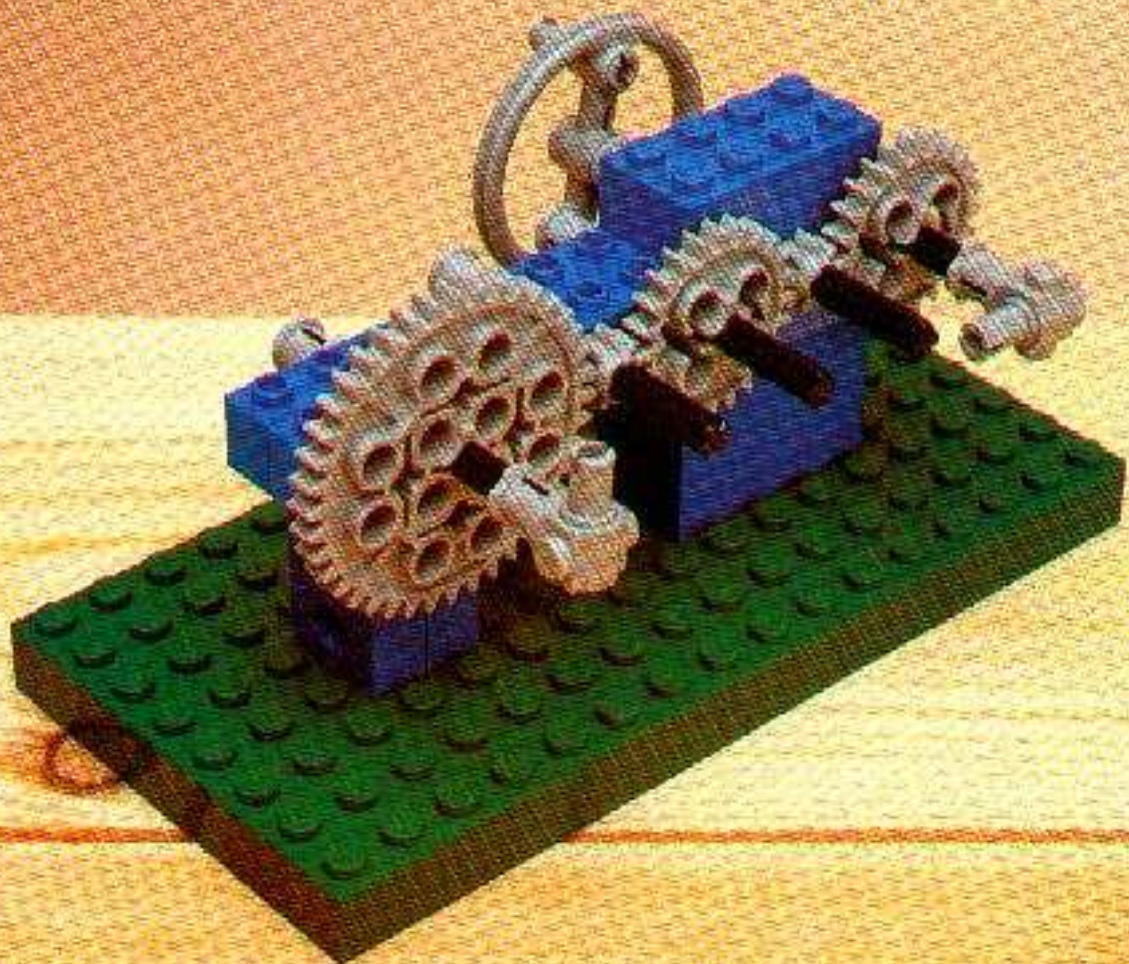
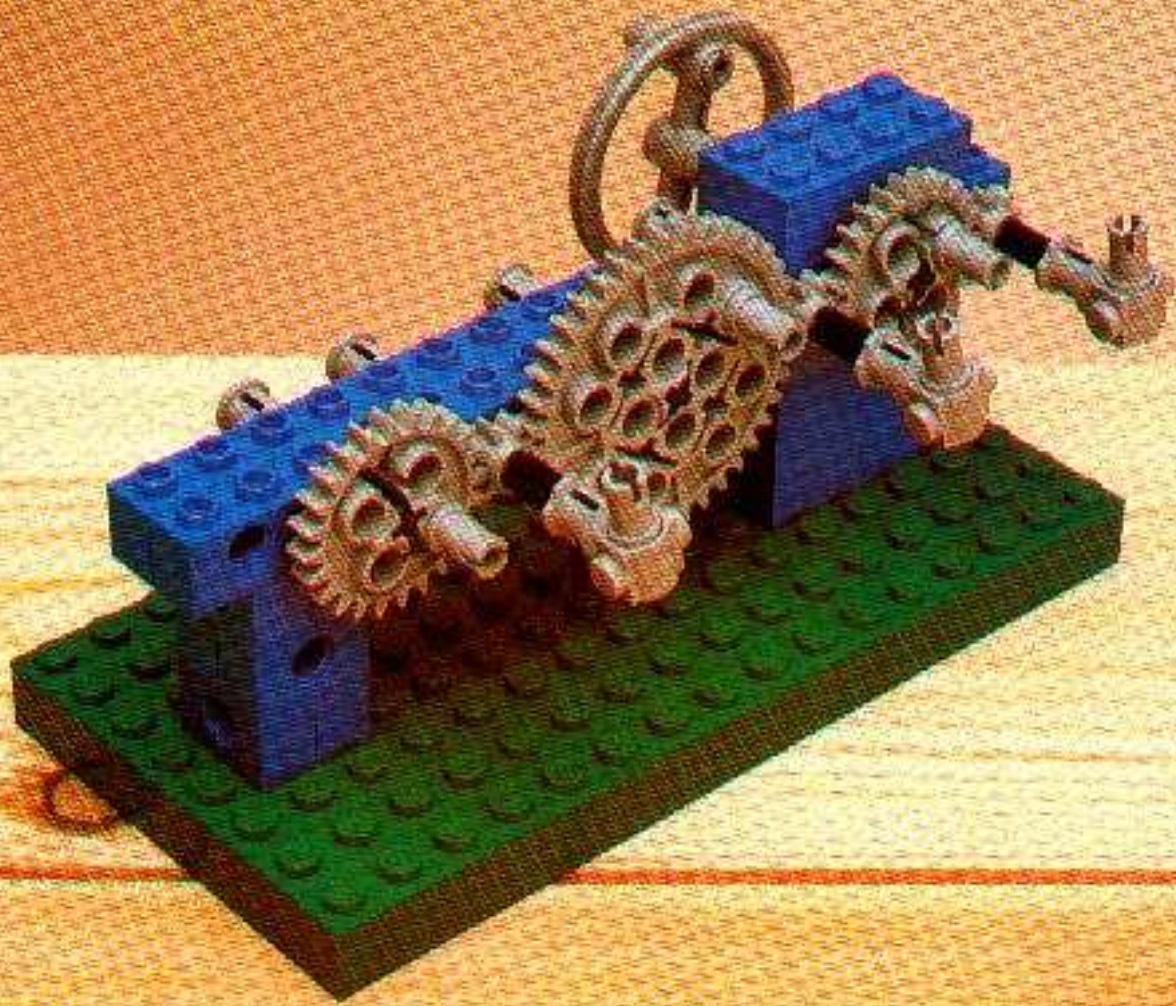

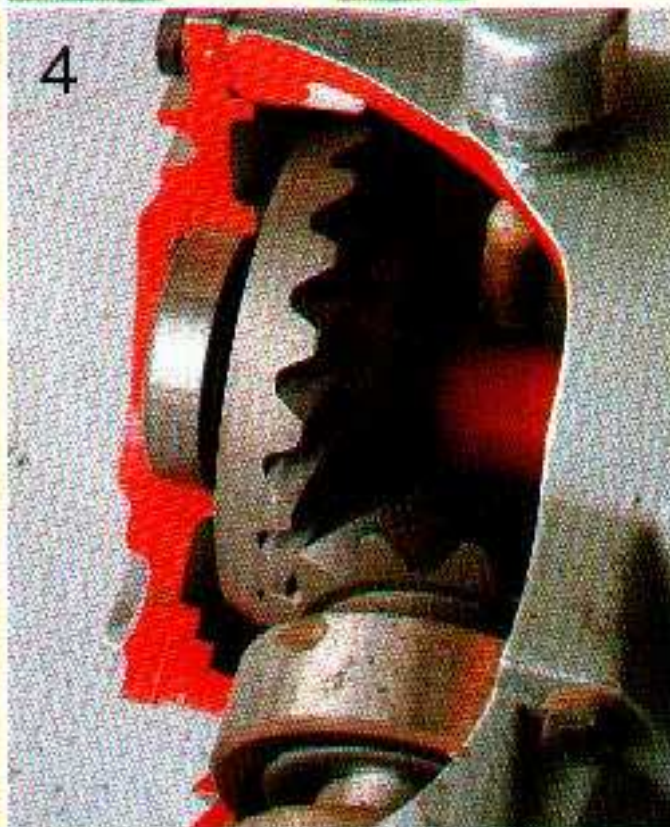
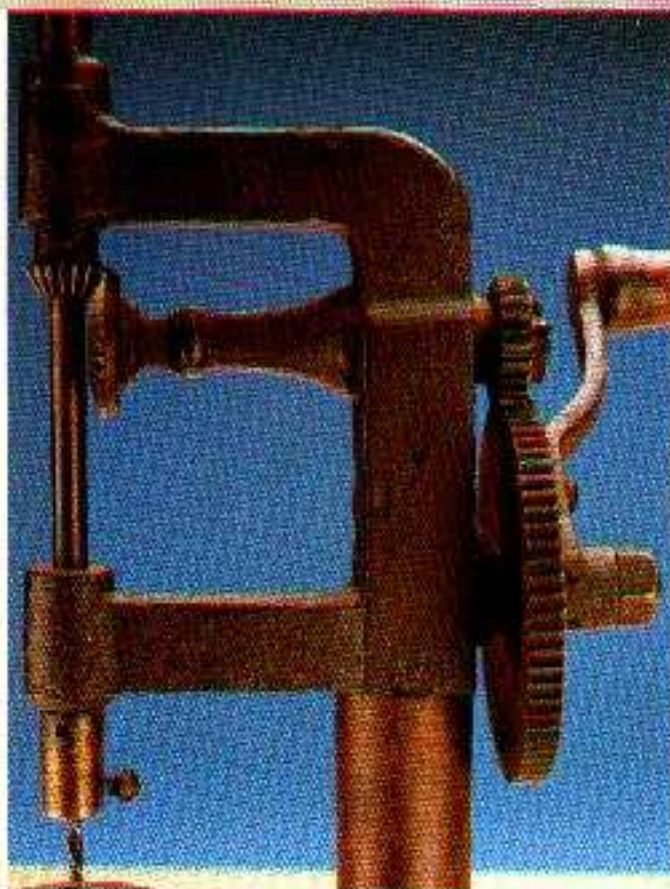

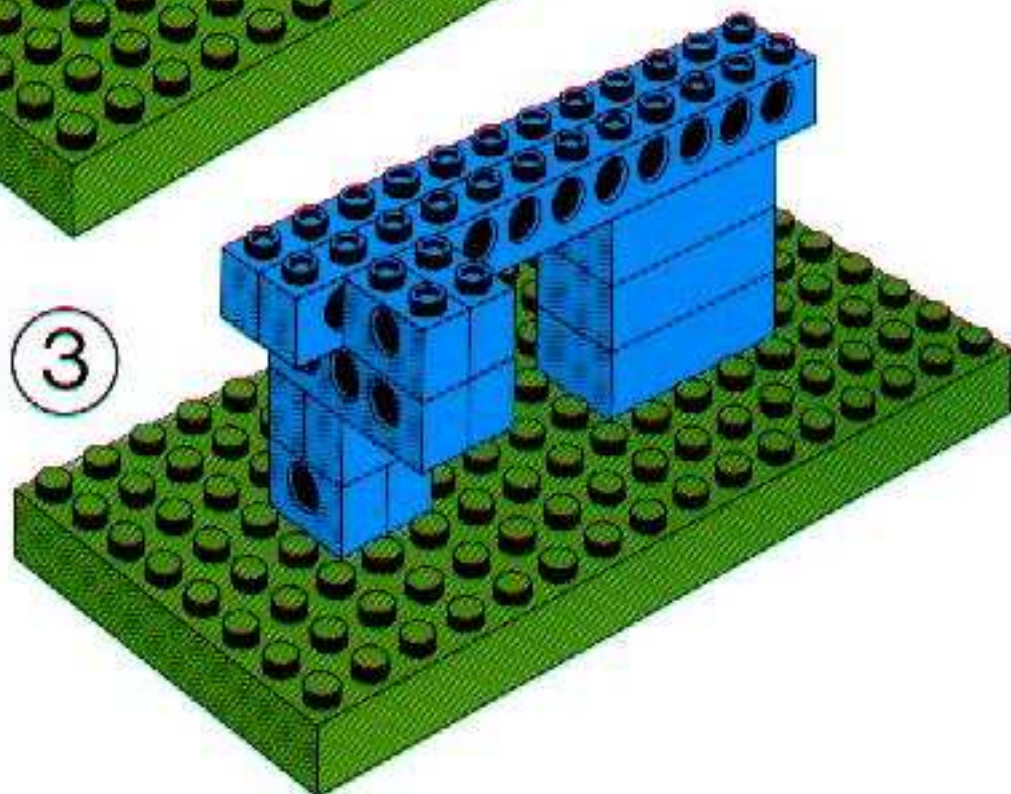
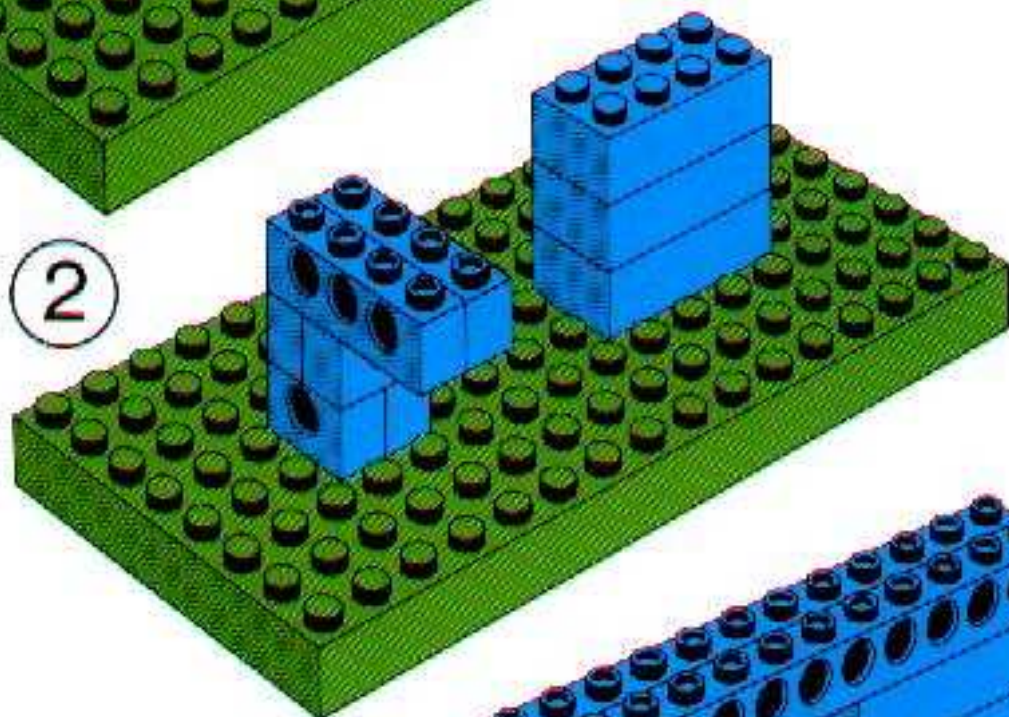
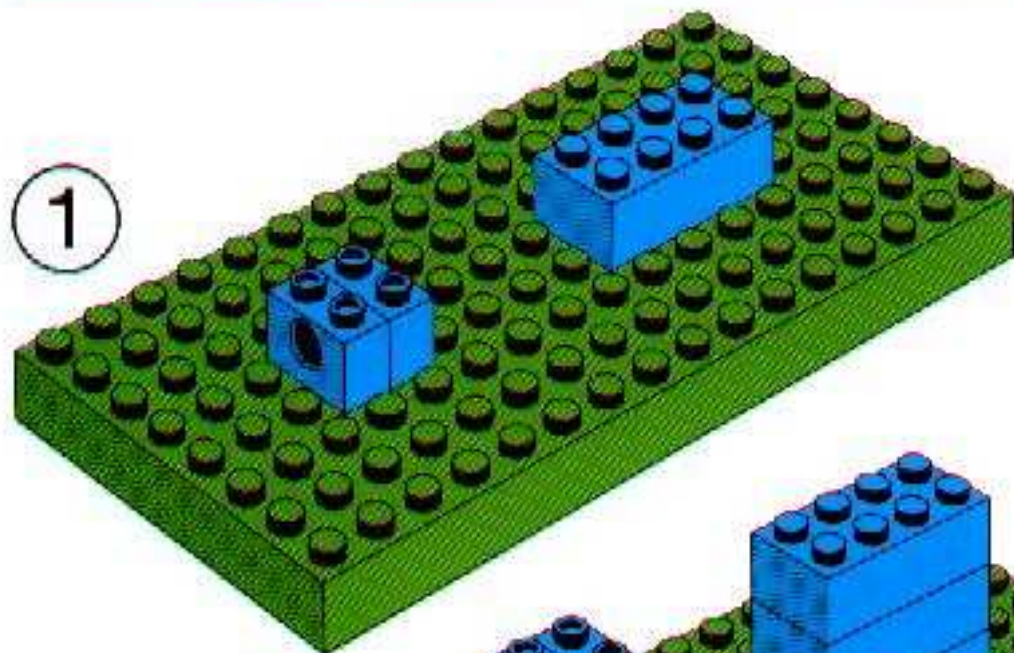
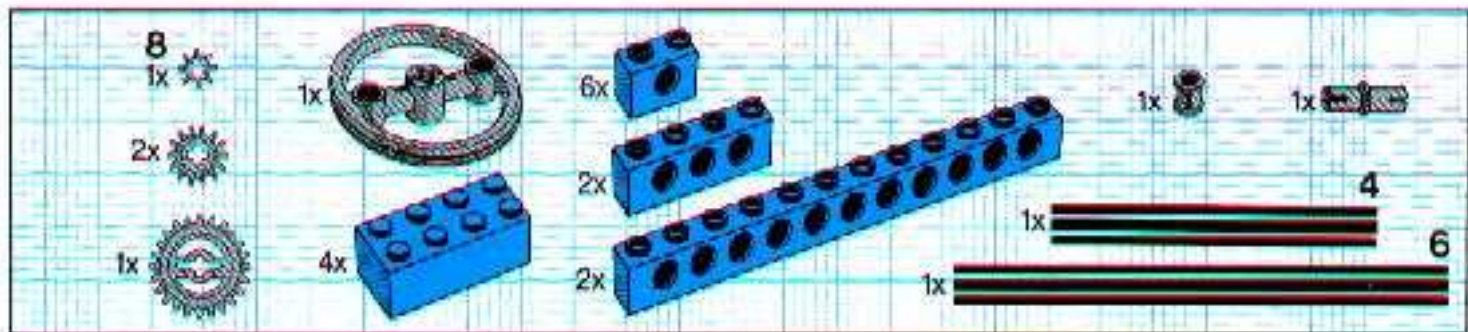

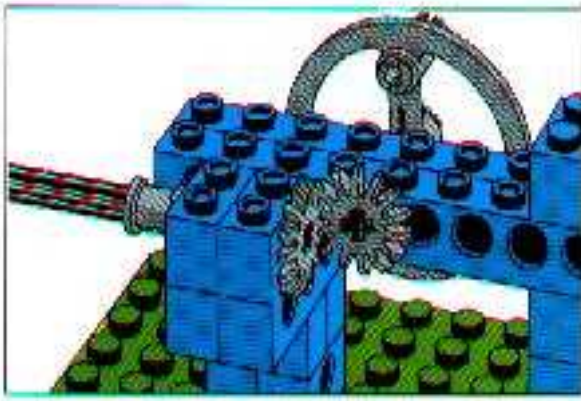

4

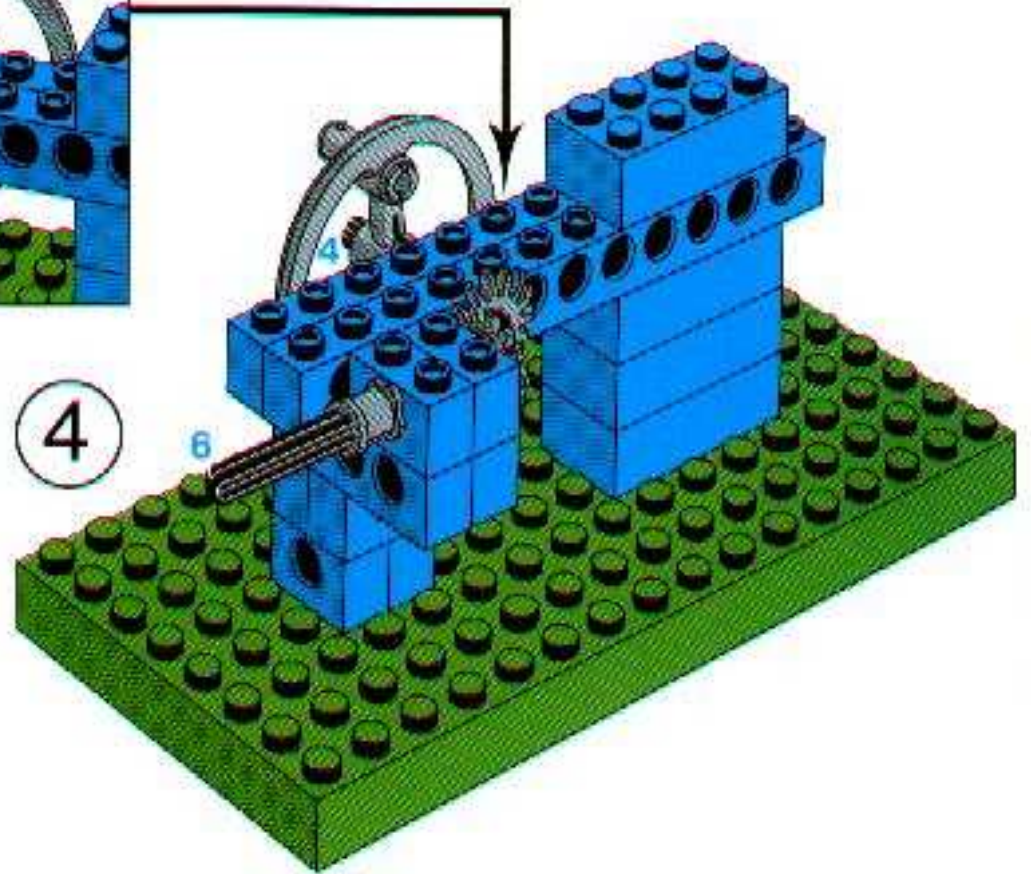

1

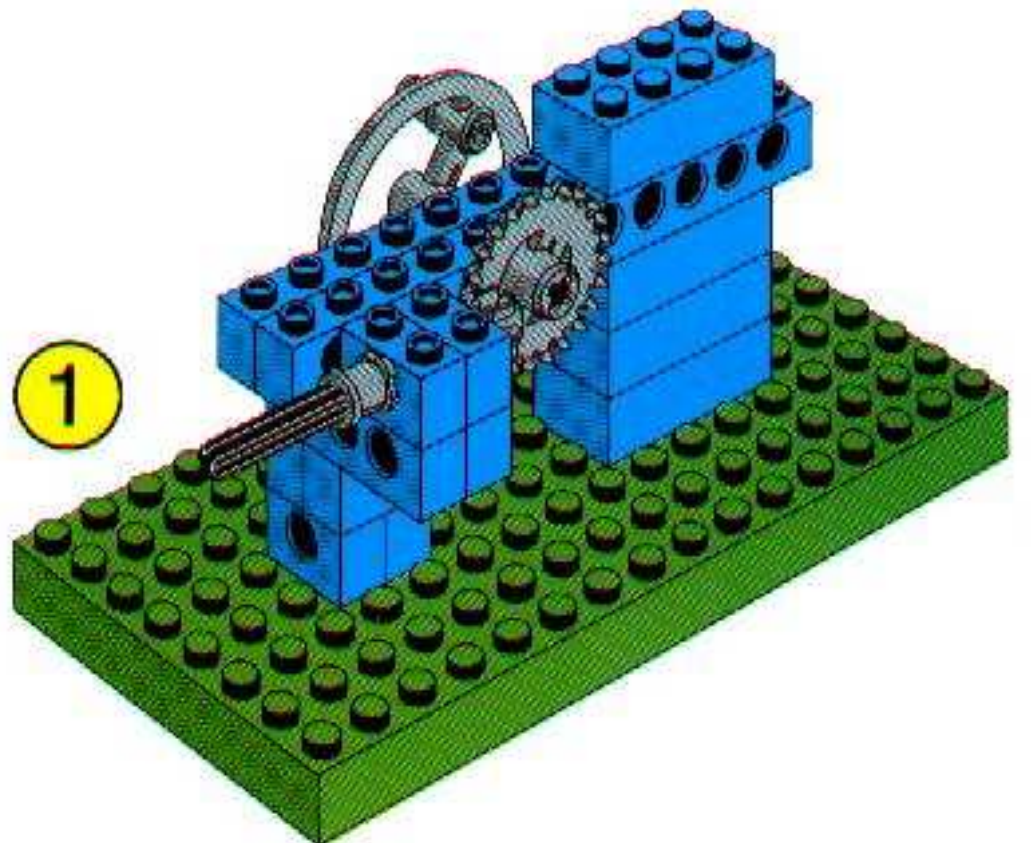

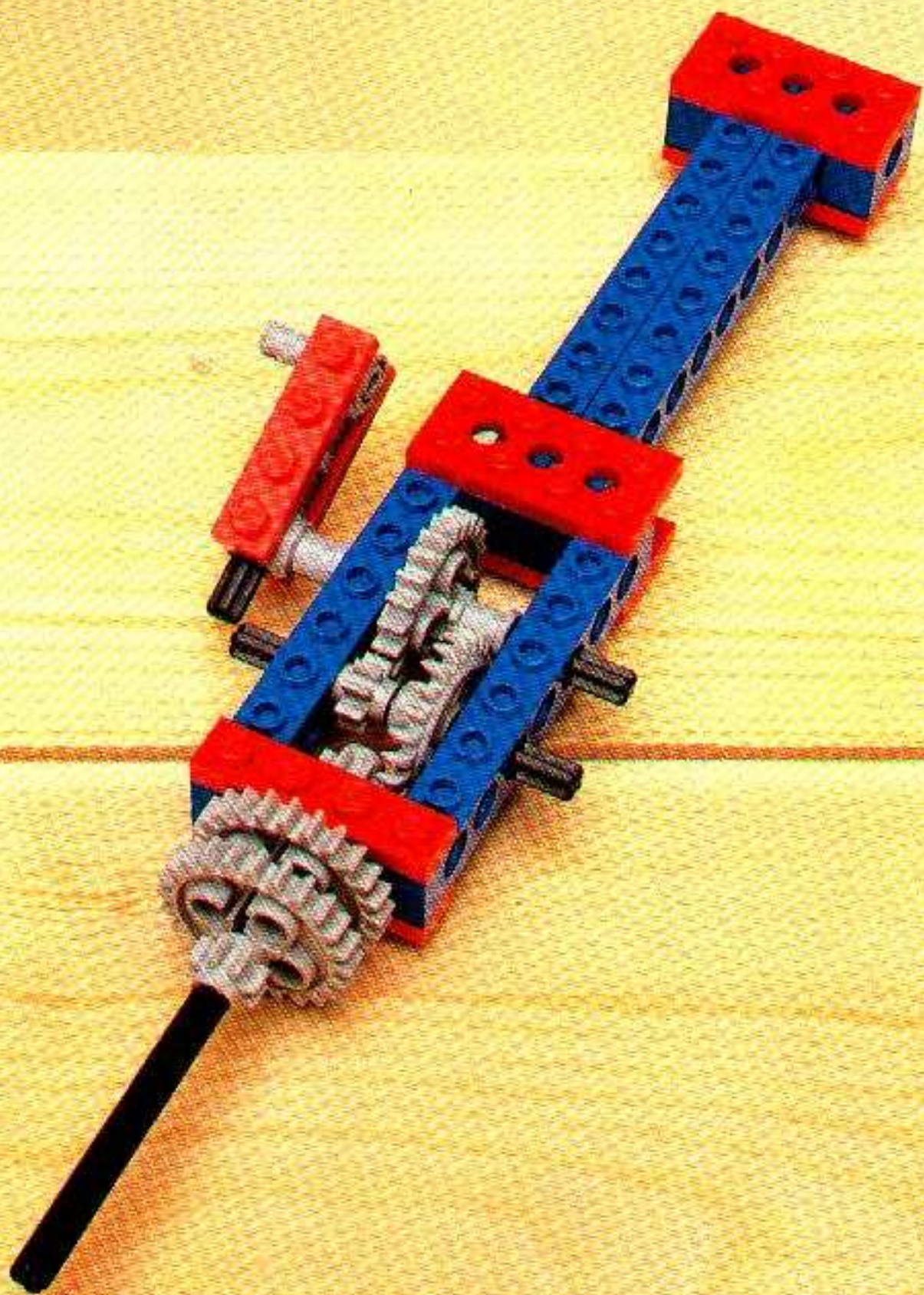



1031

8

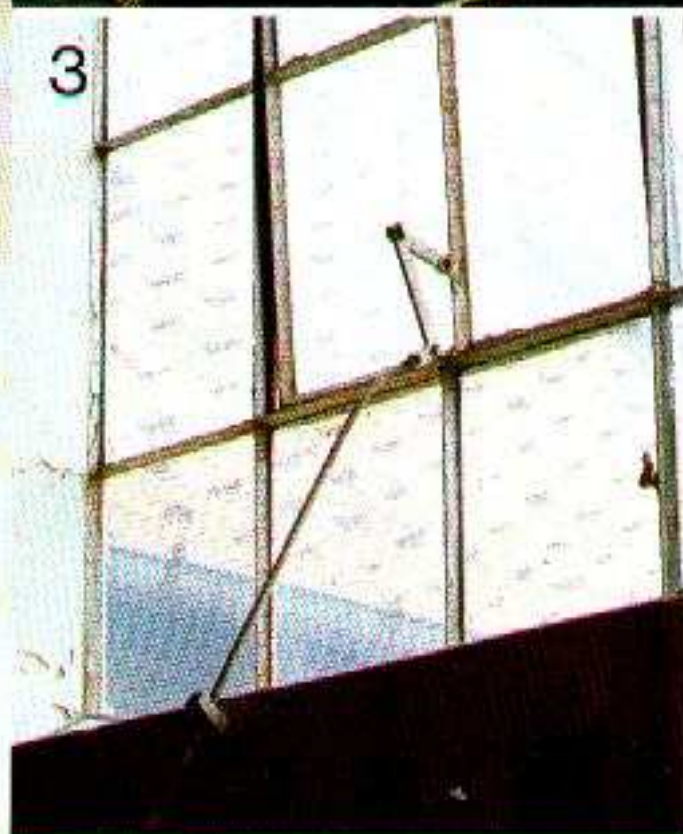

 **dacta**

Technic

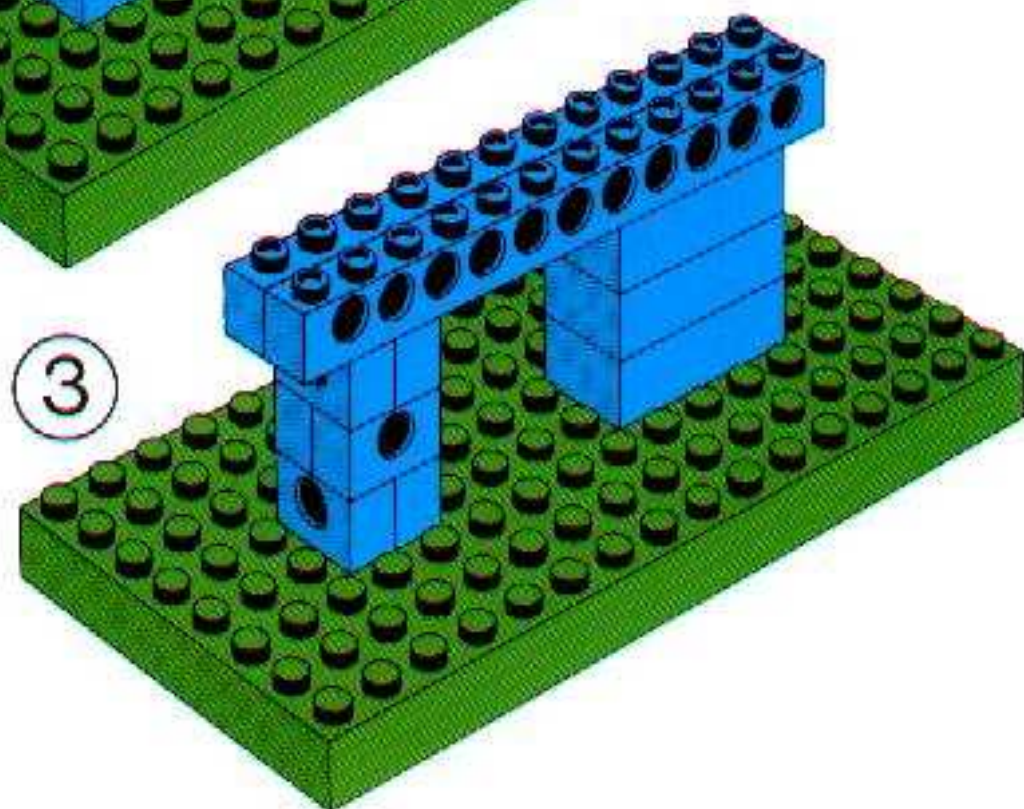
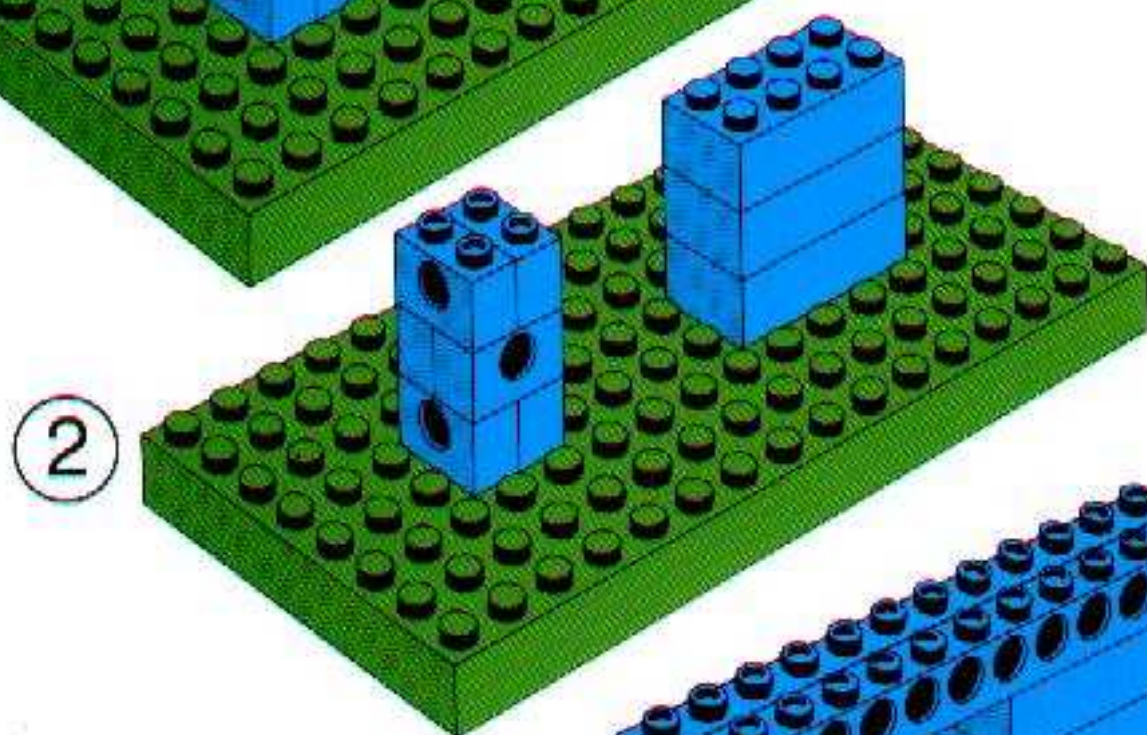
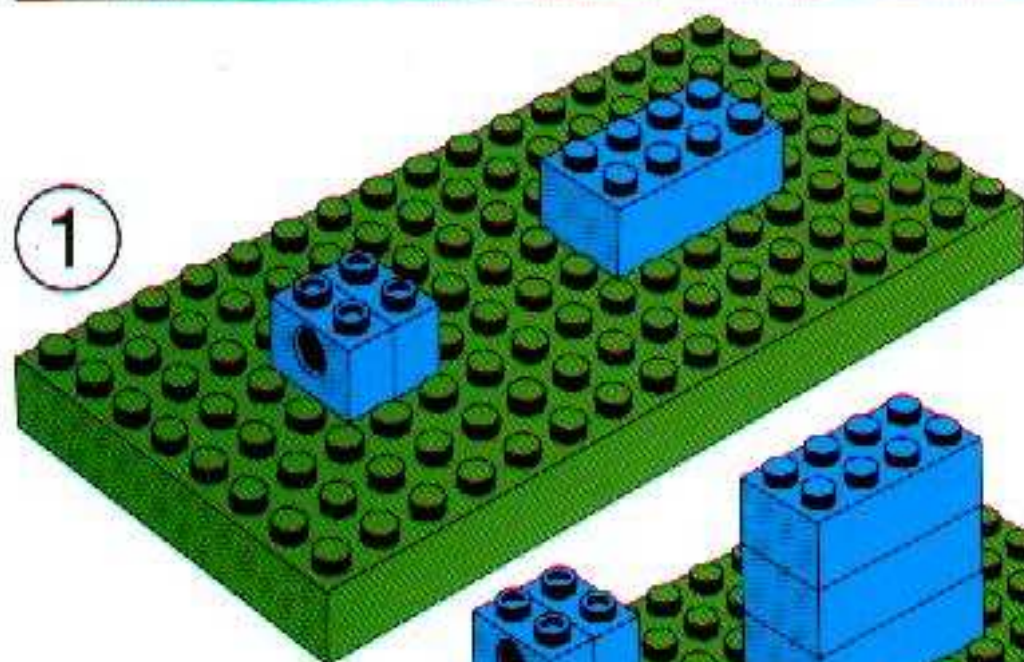
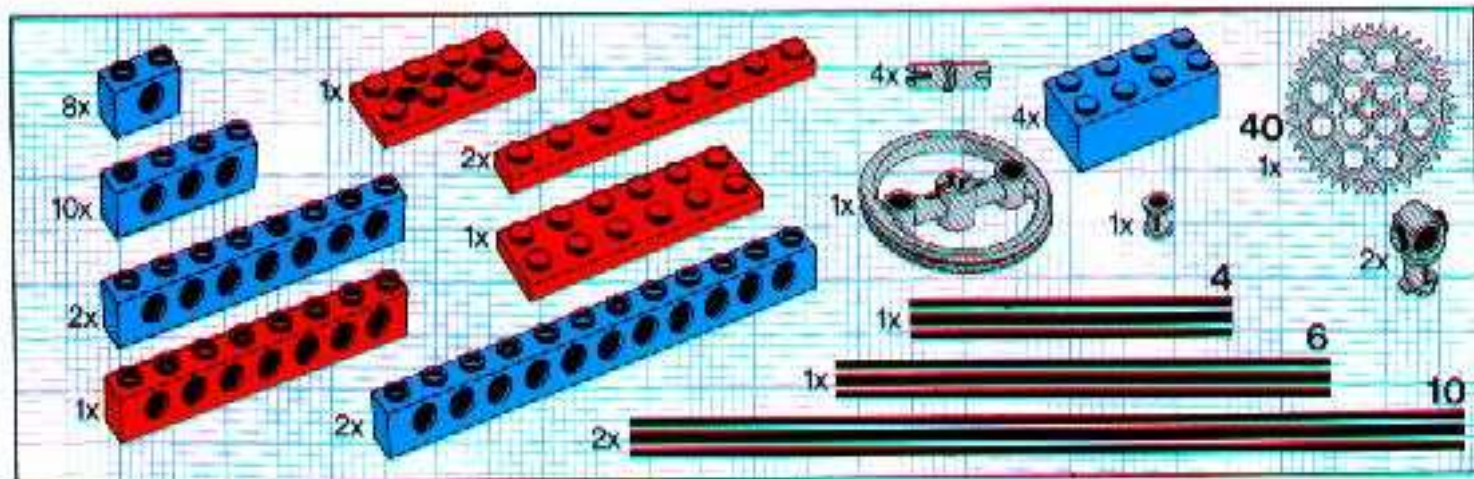

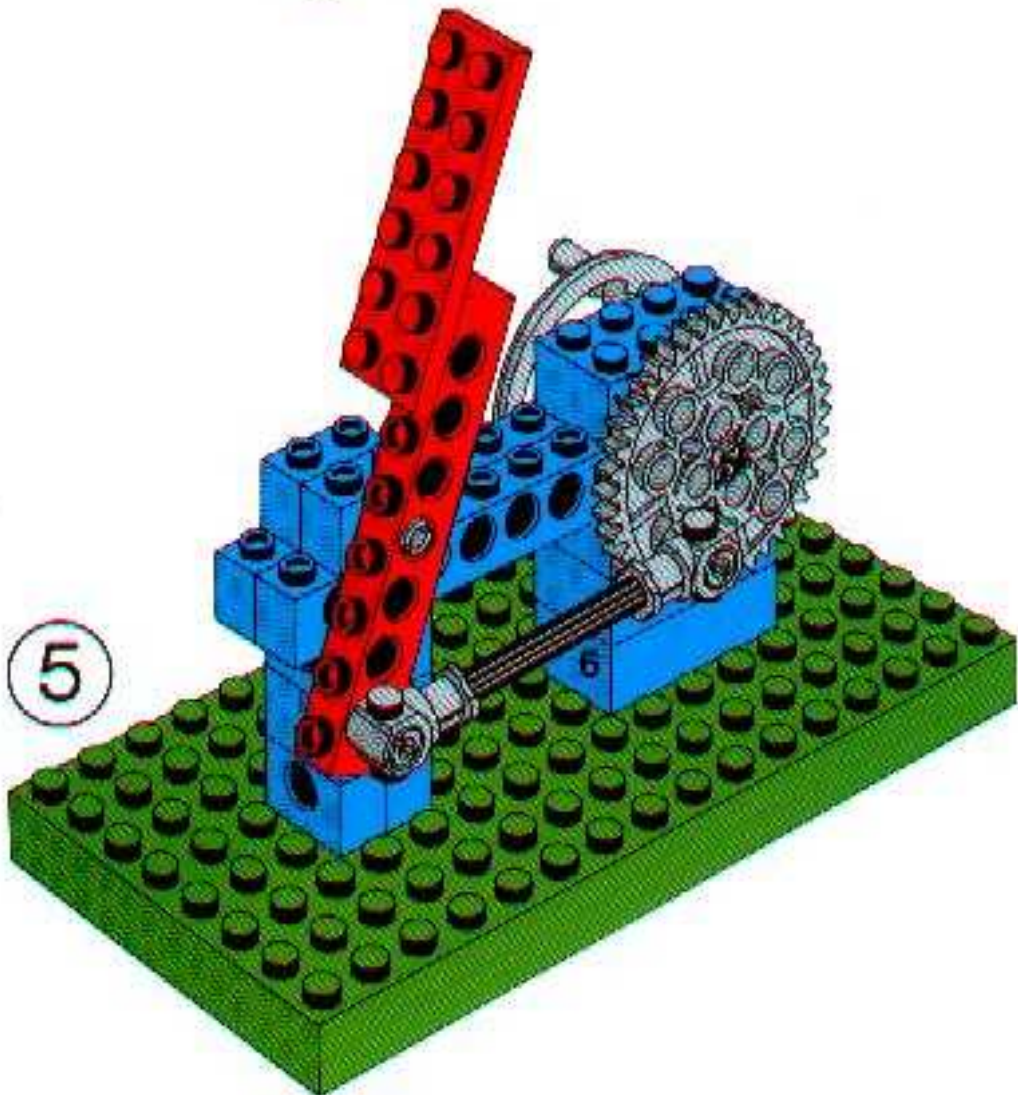
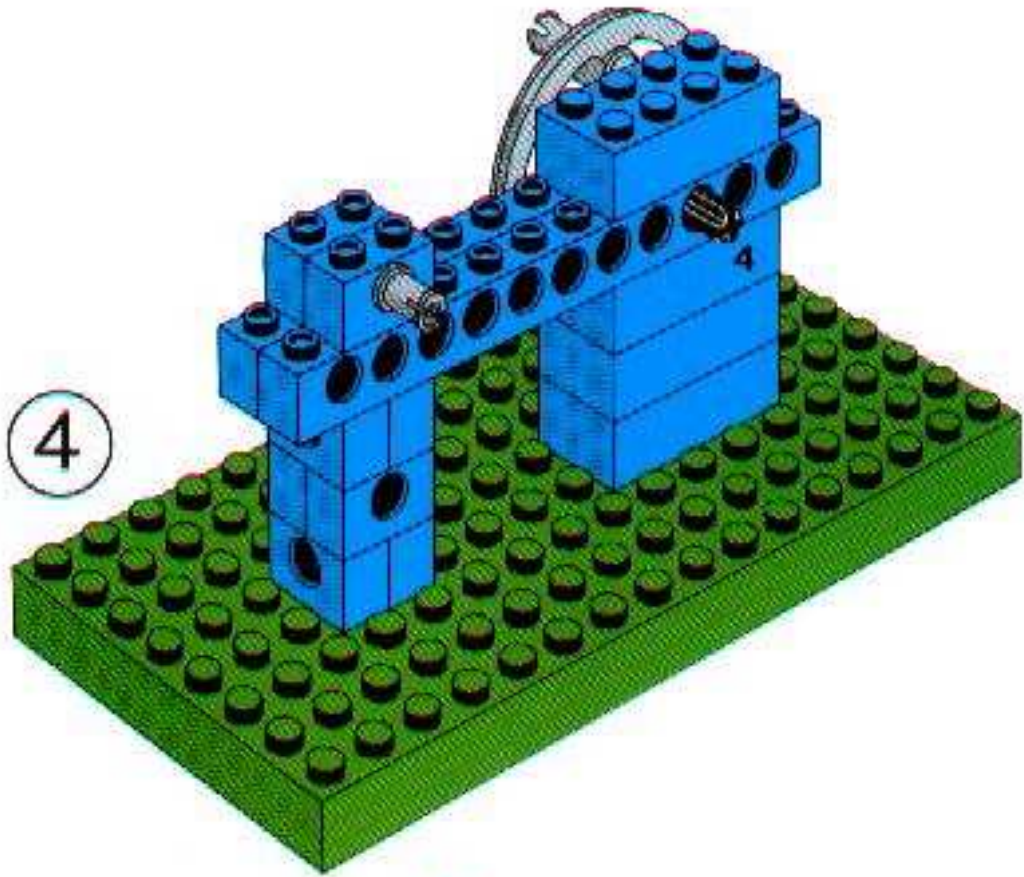

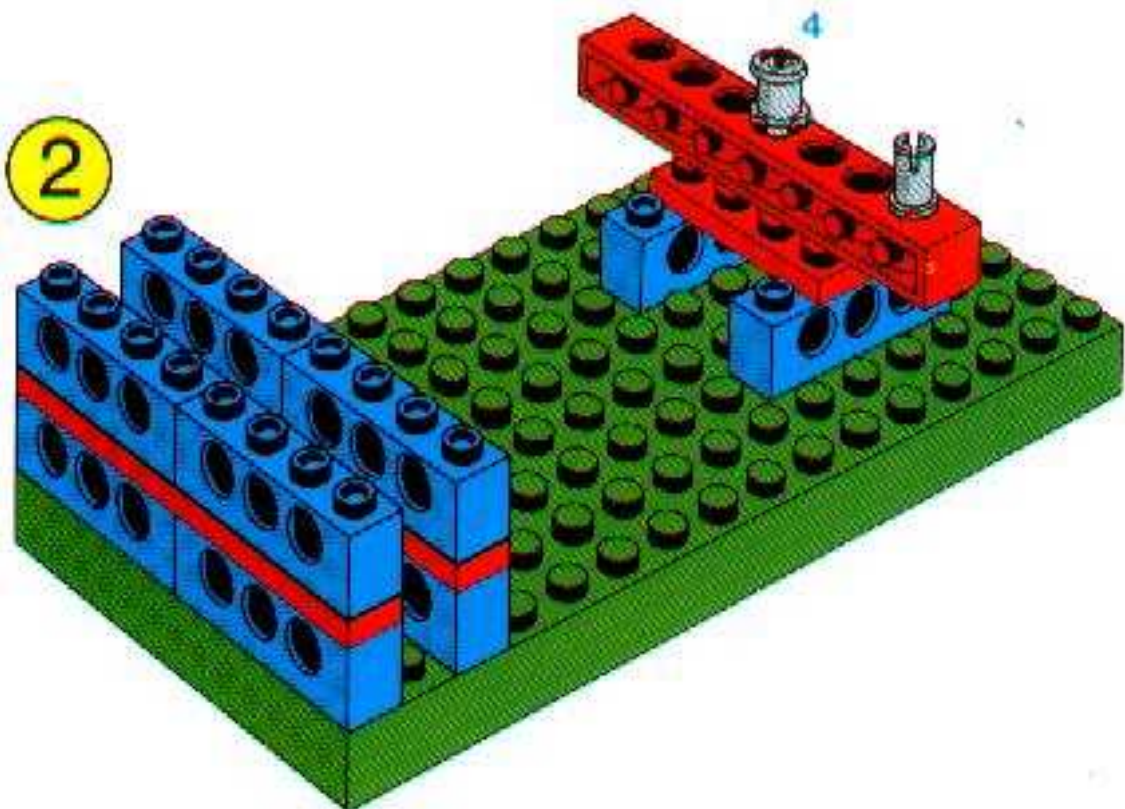
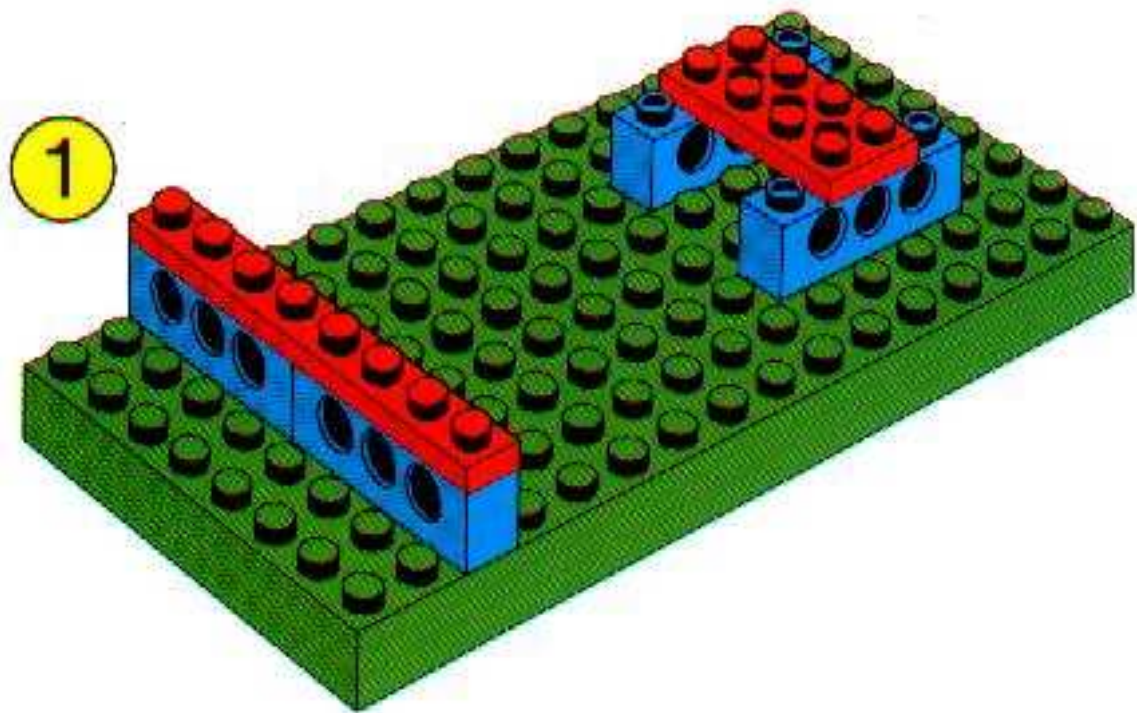

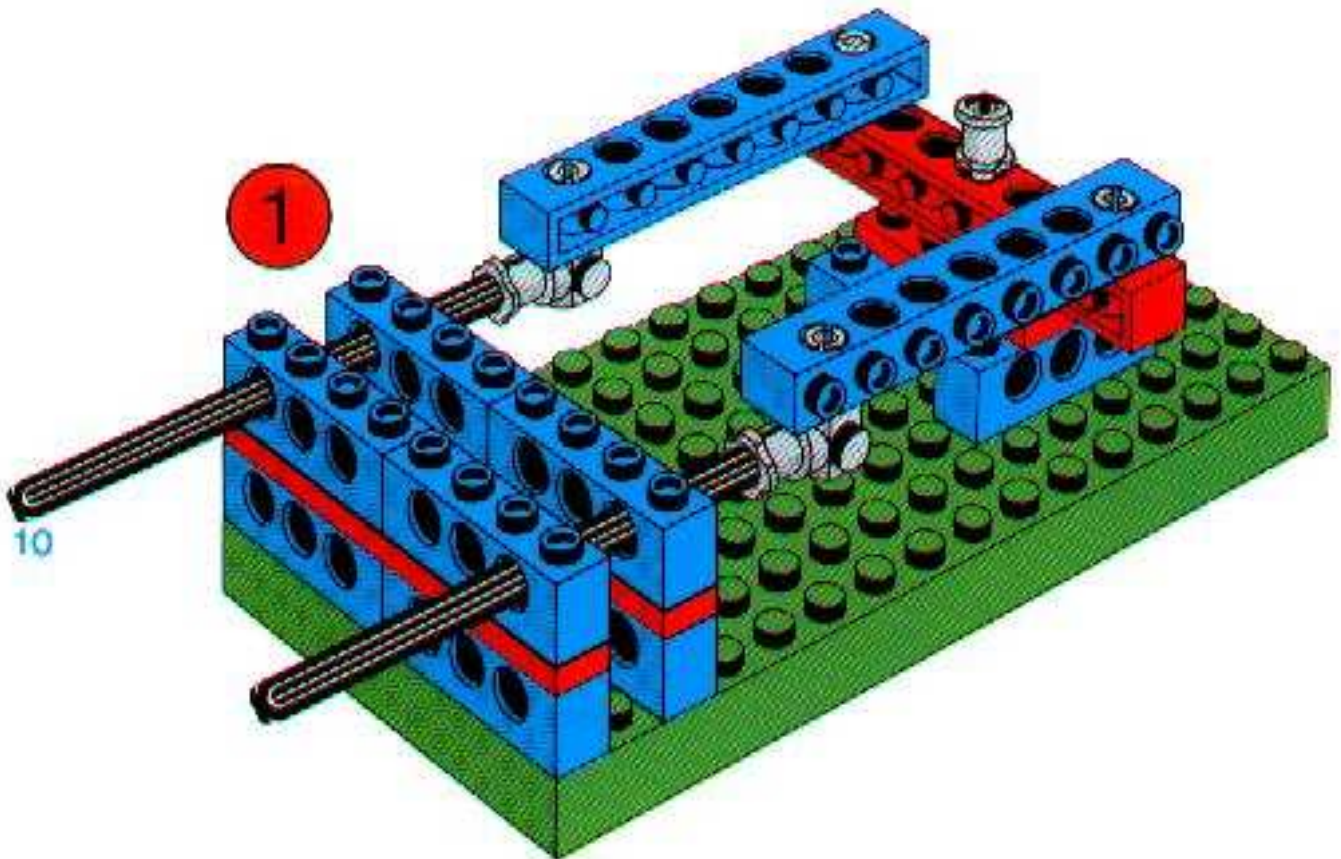
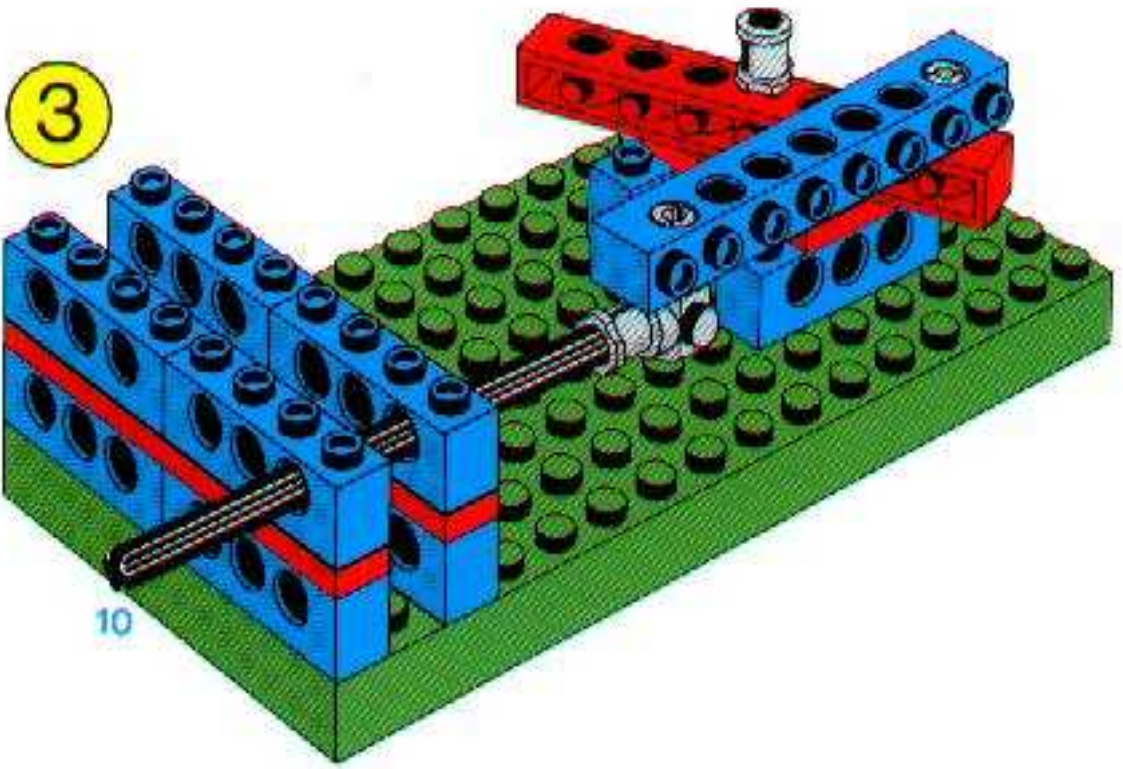

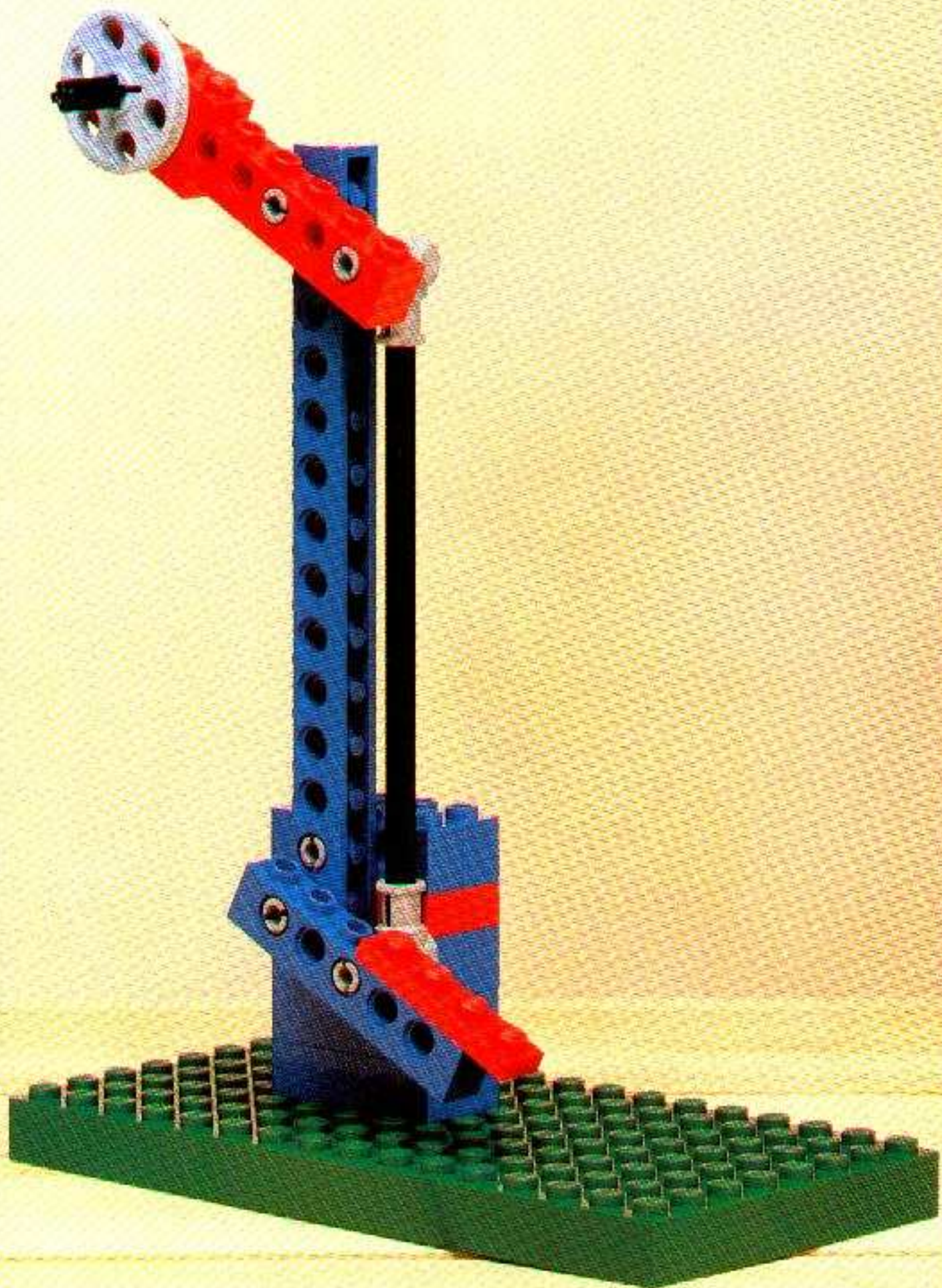

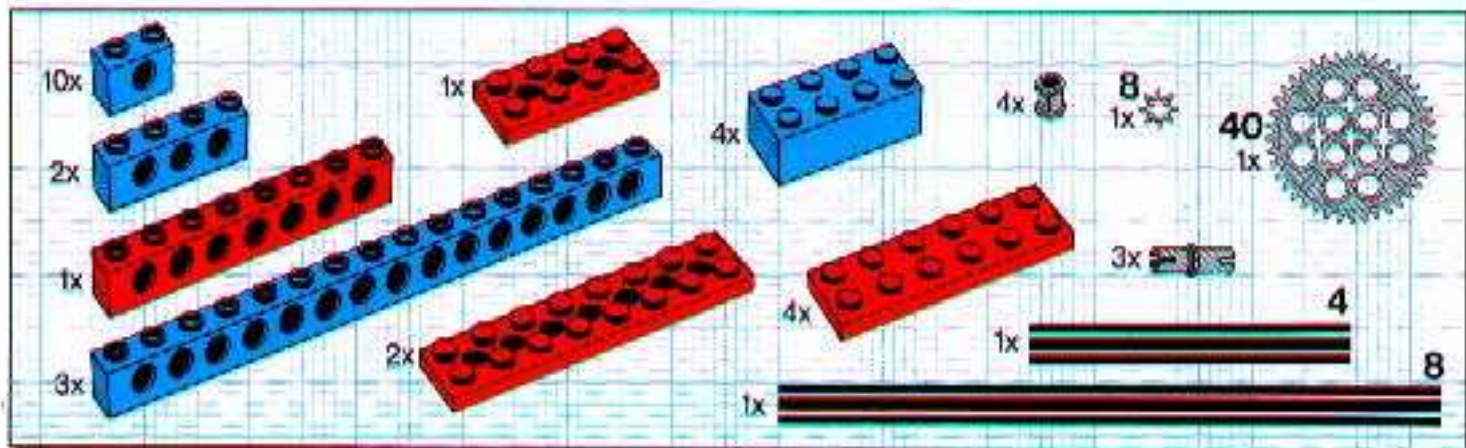

1

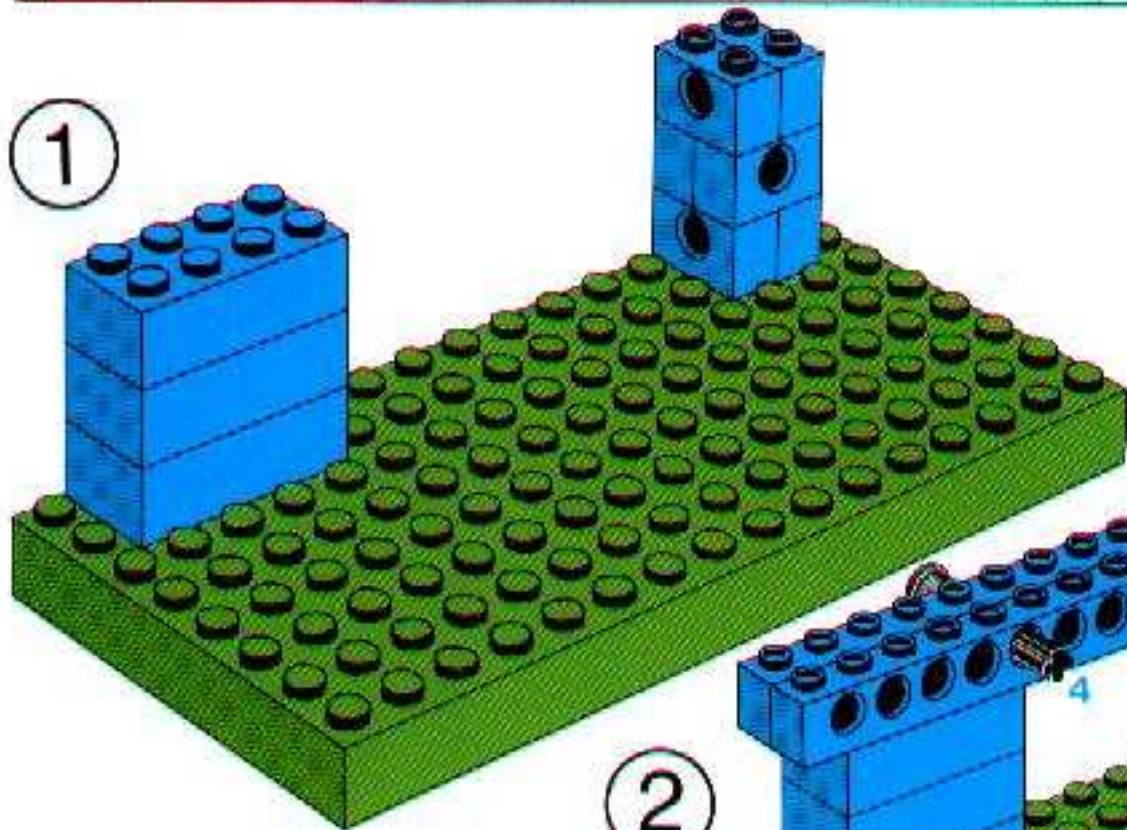

2

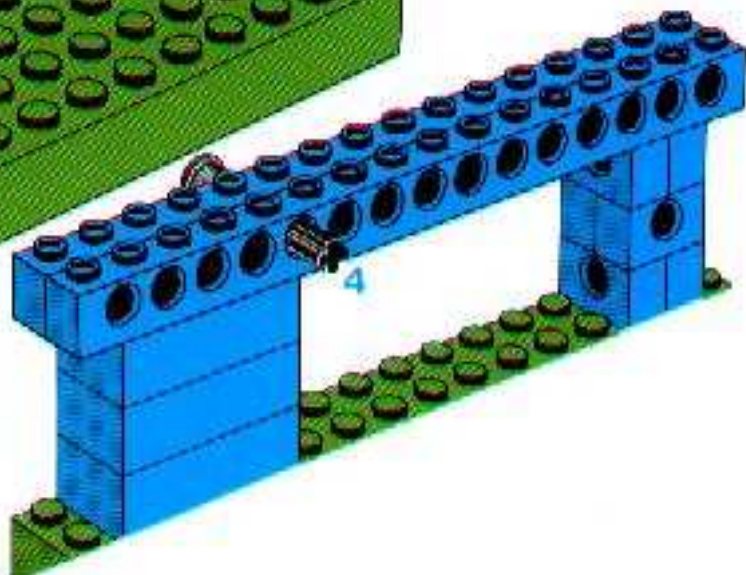

3

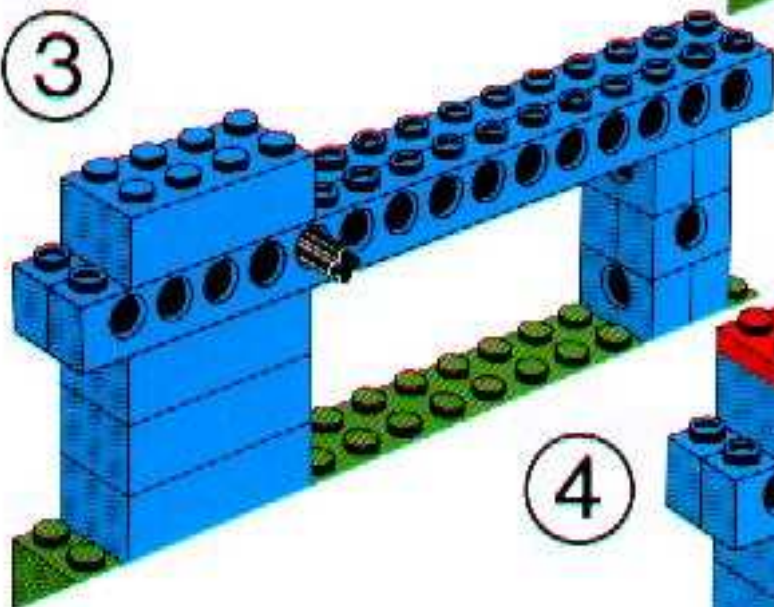

4

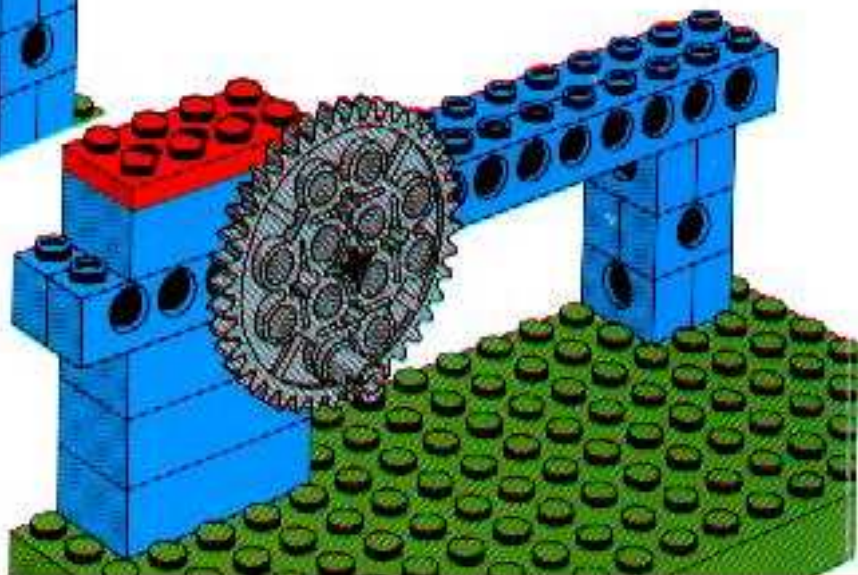

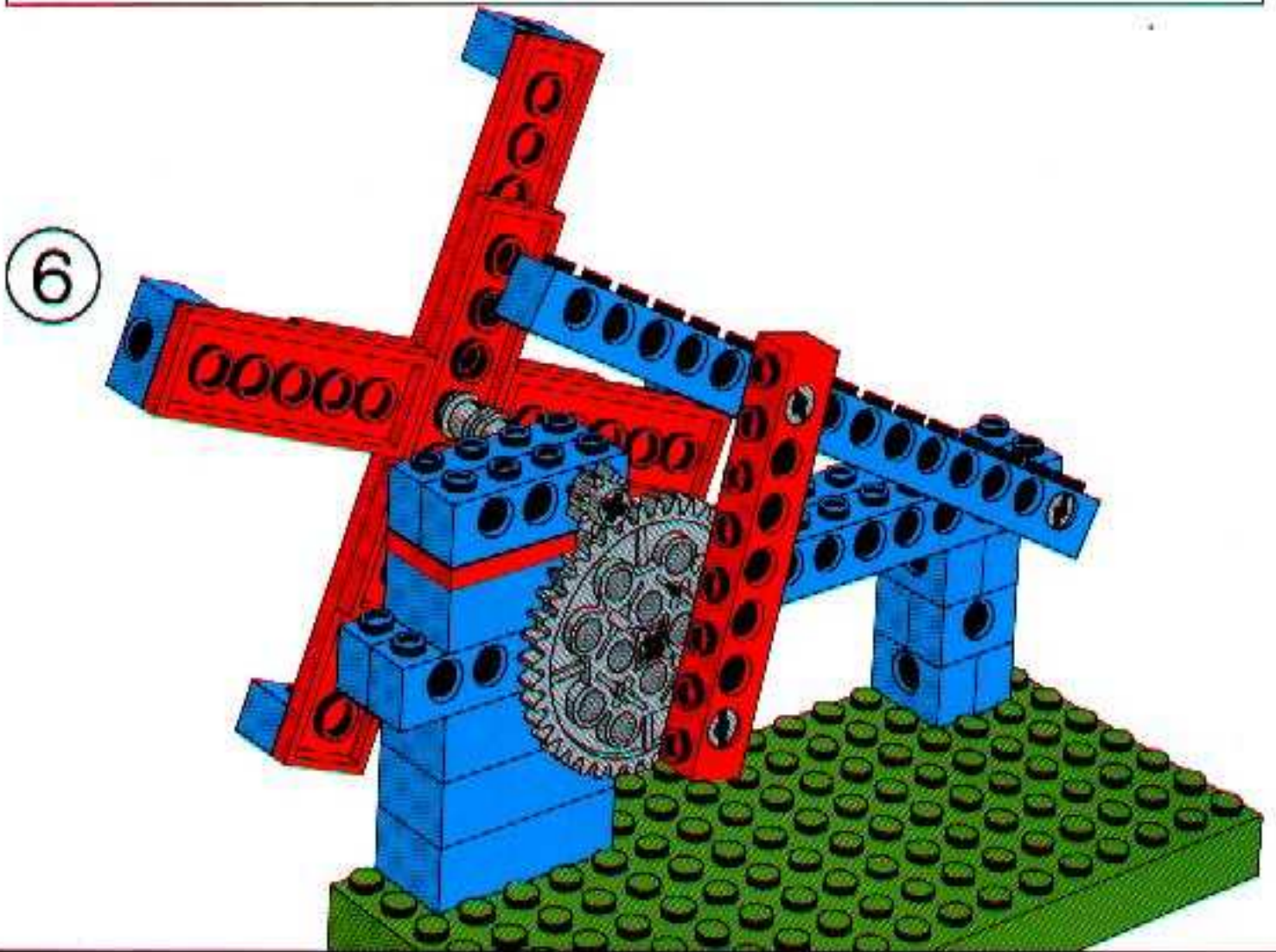
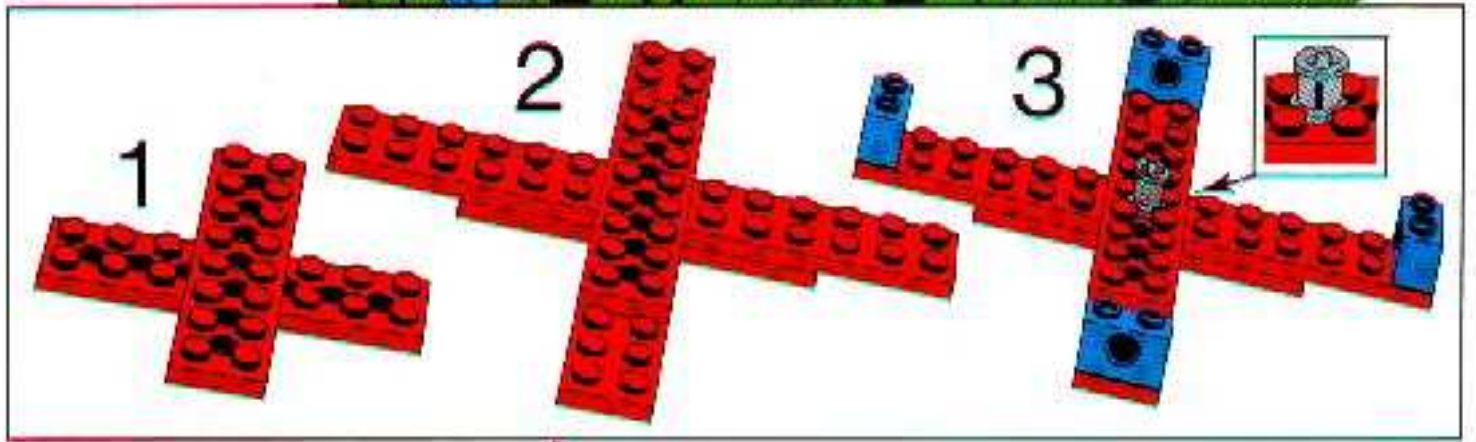
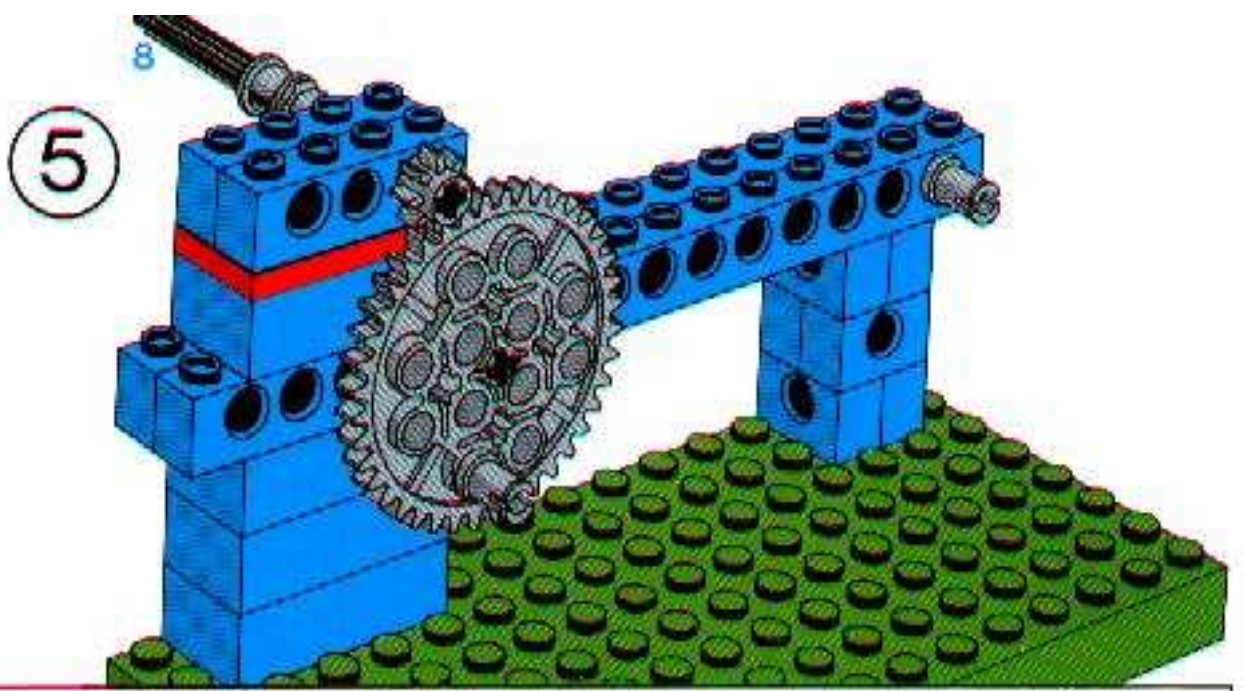

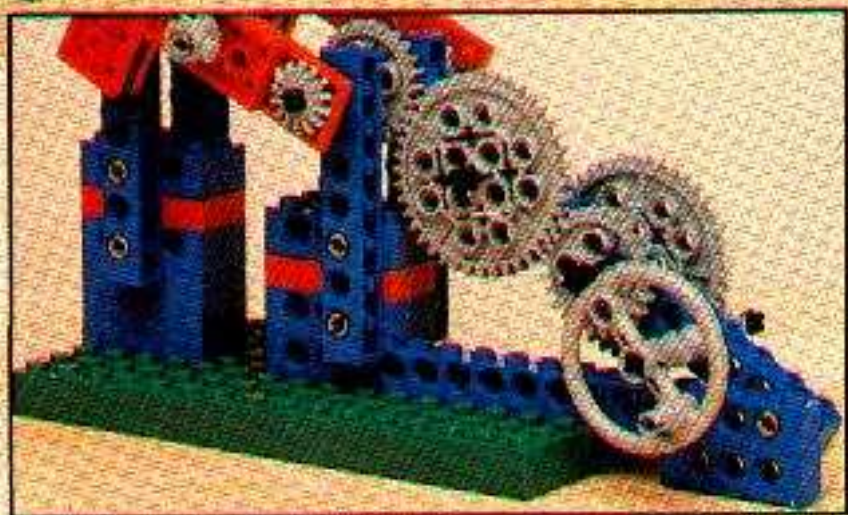
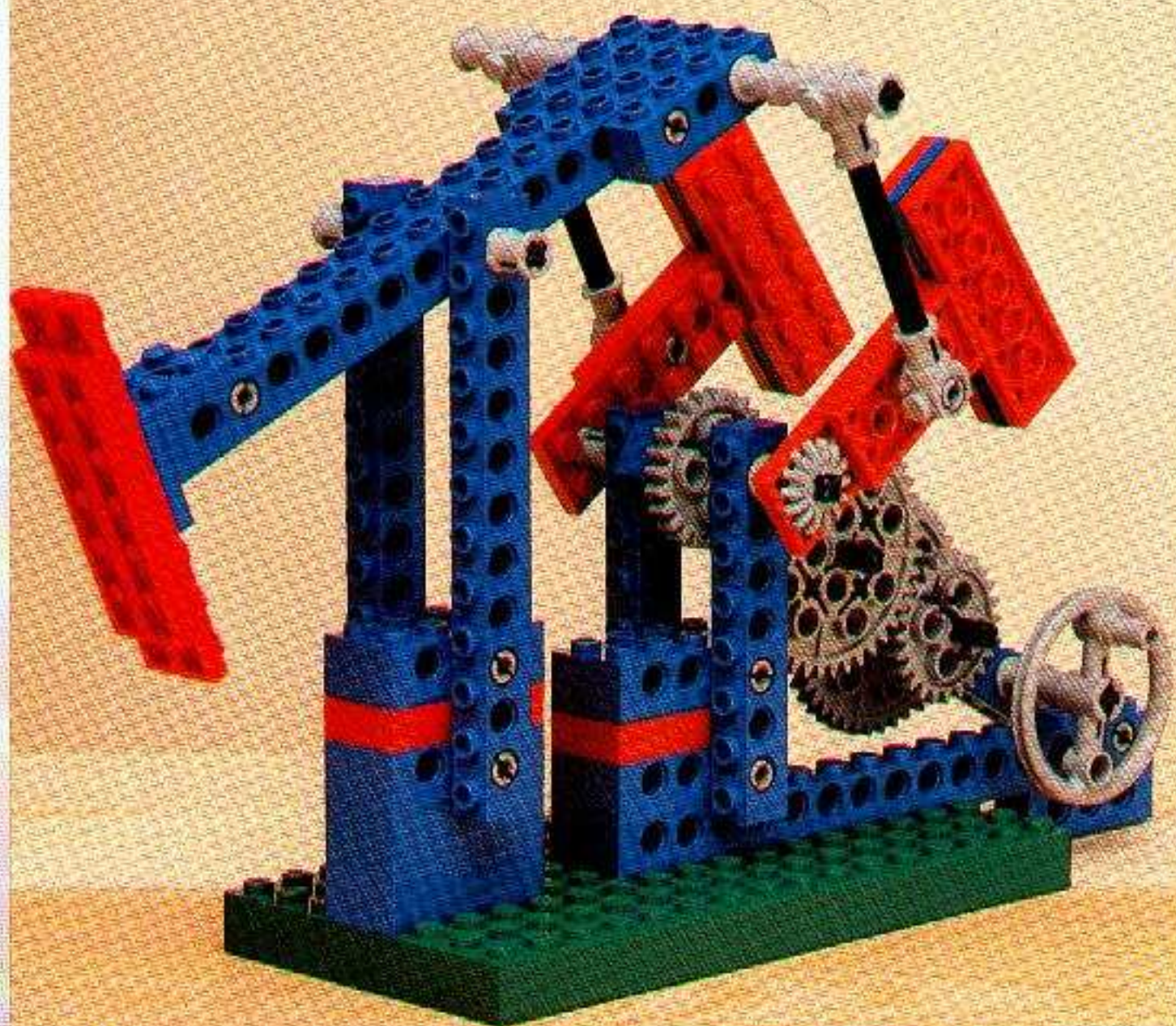



1031

10



LEGO dacta

Technic

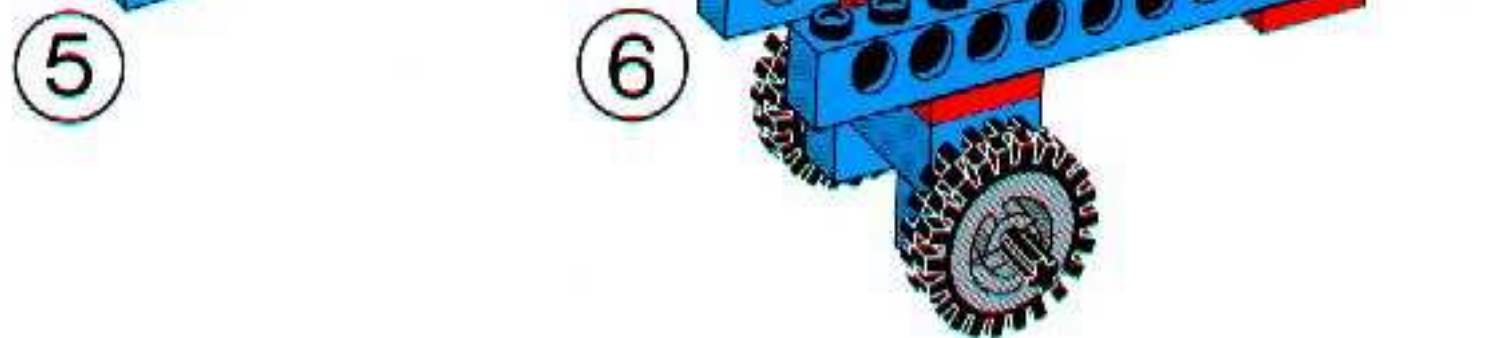
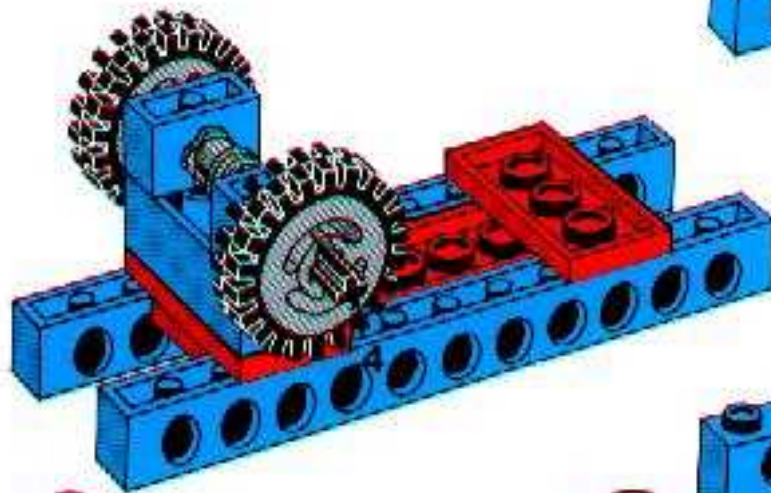
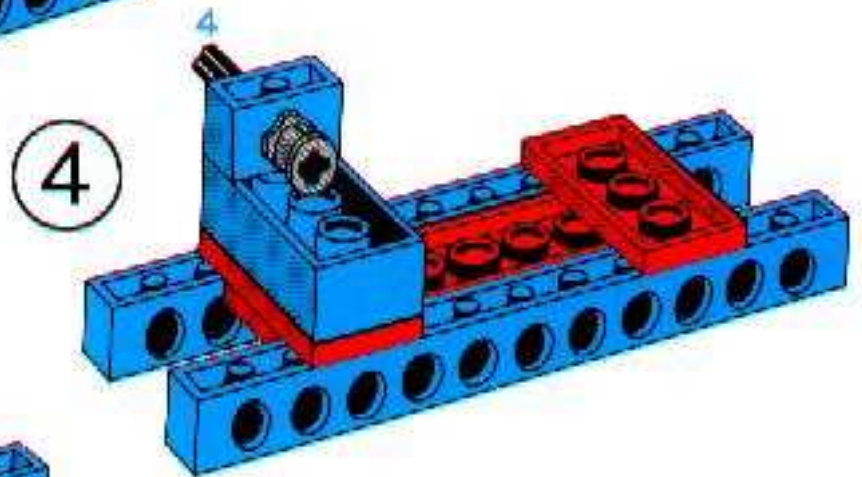
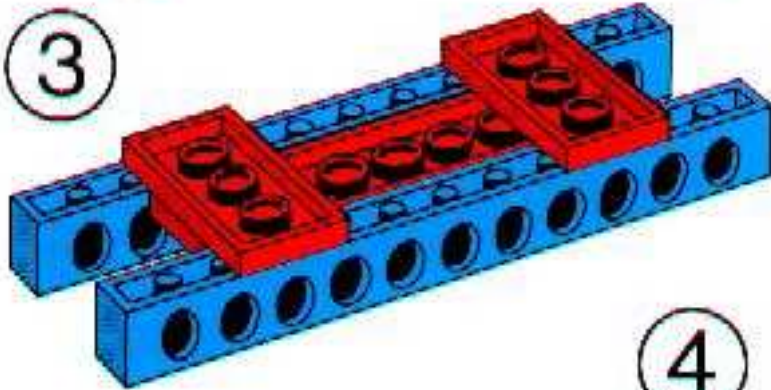
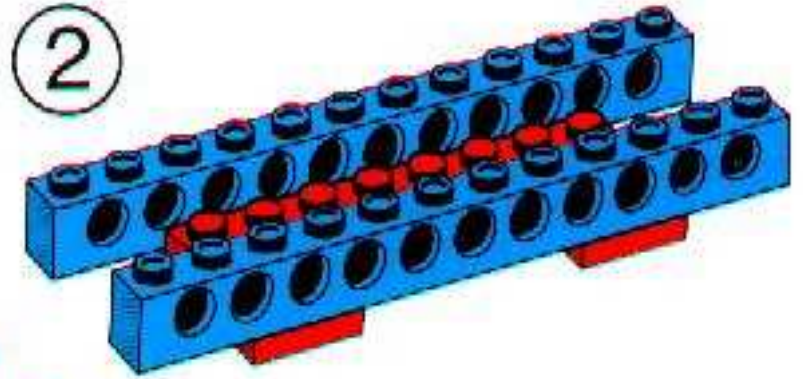
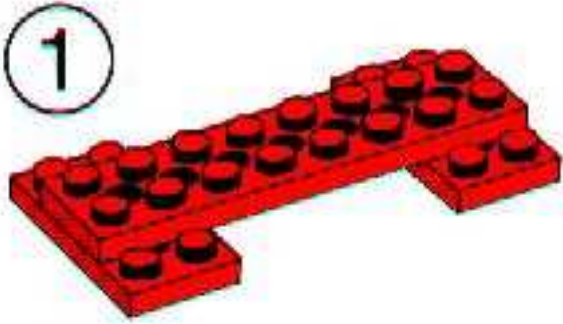
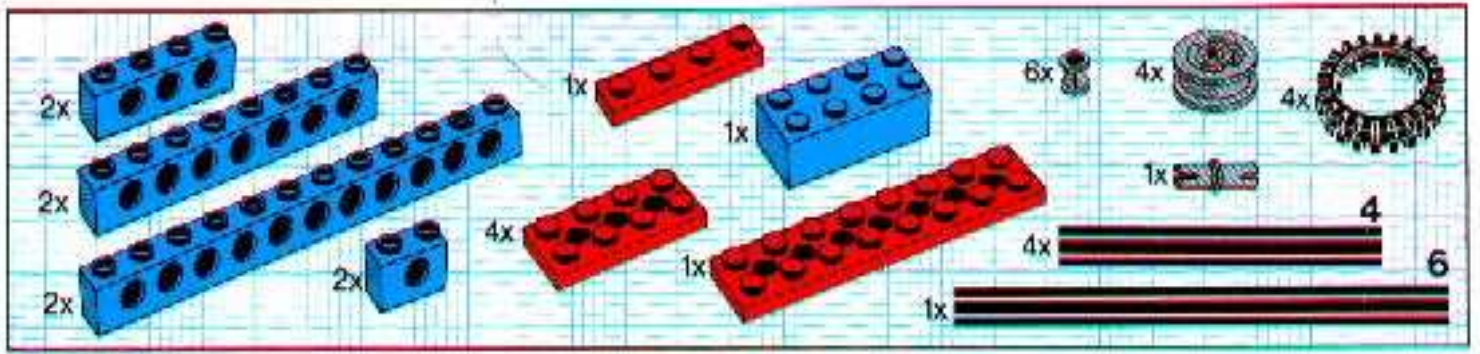

1

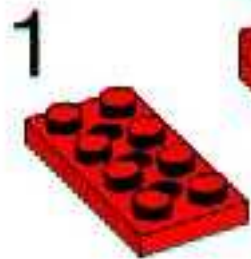

2



3

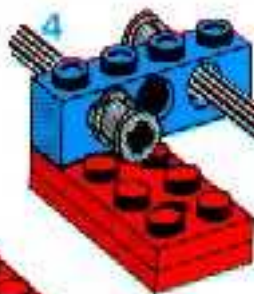

4

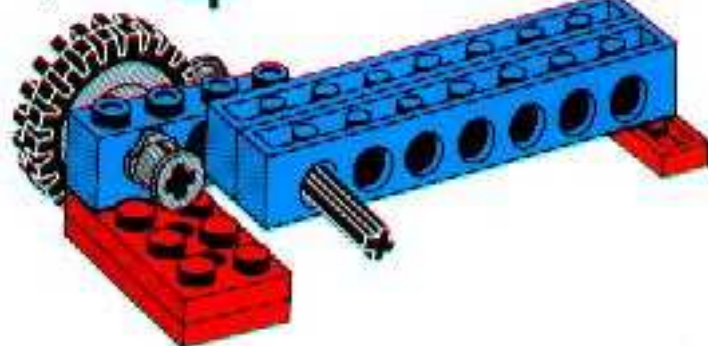

5

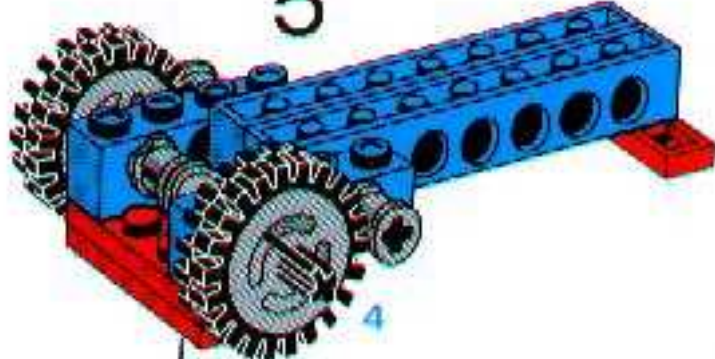

2

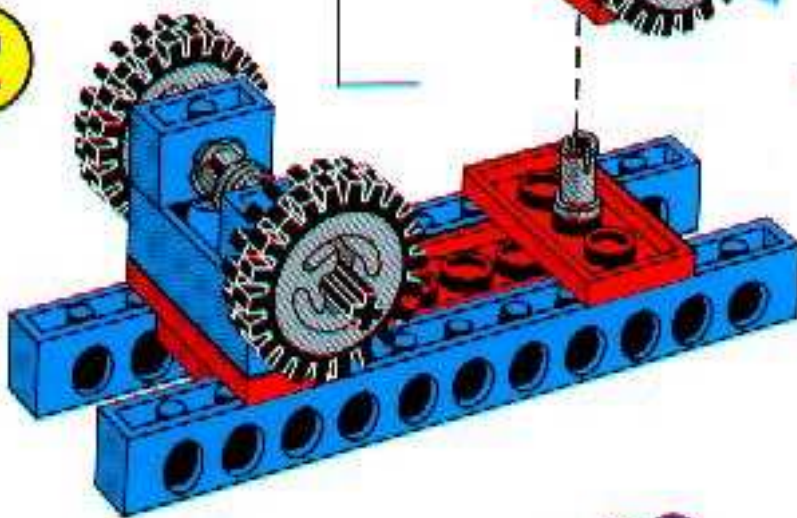

3

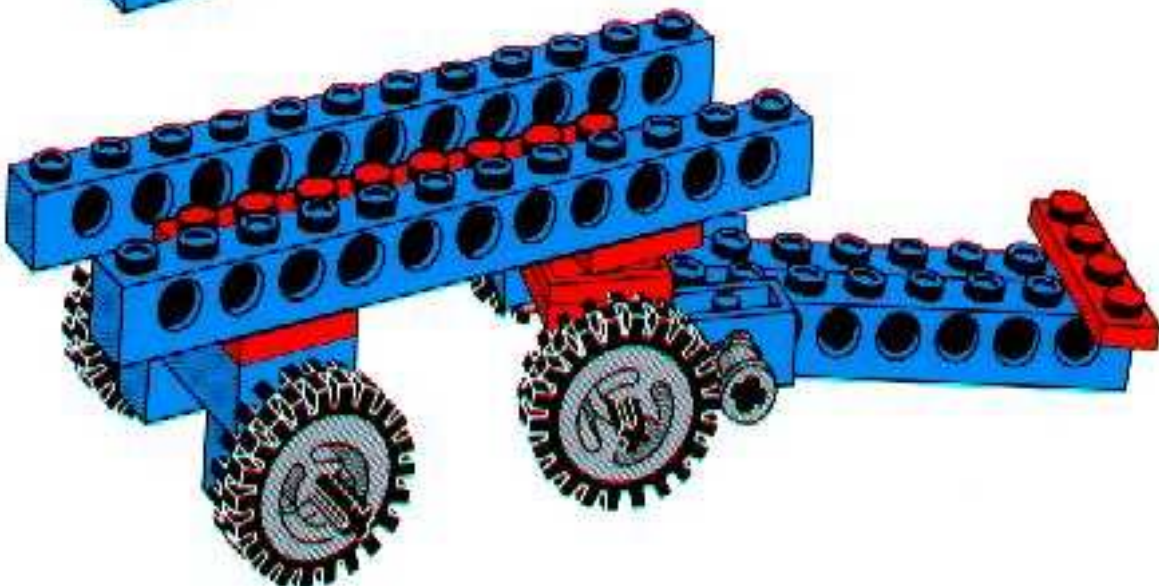

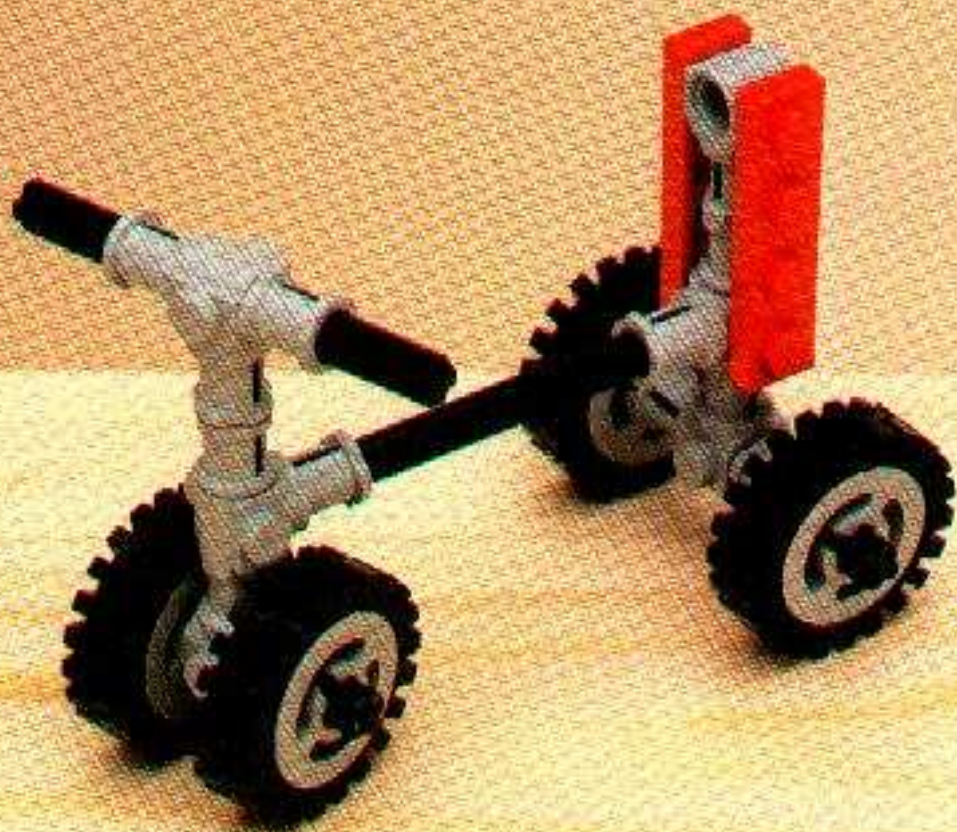
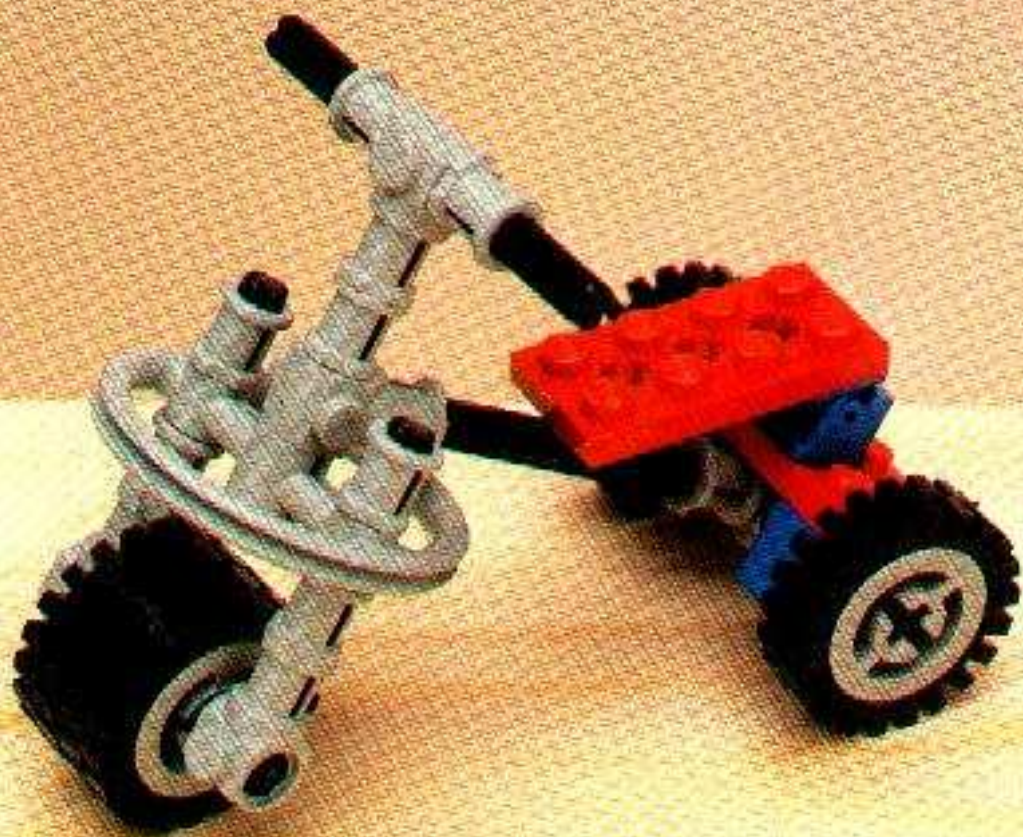



1031

11

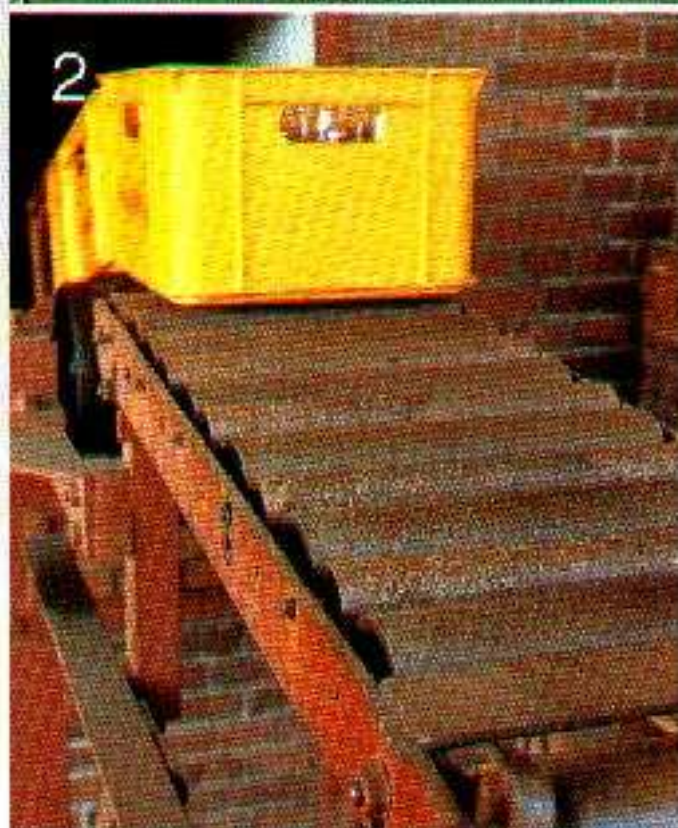

LEGO dacta

Technic

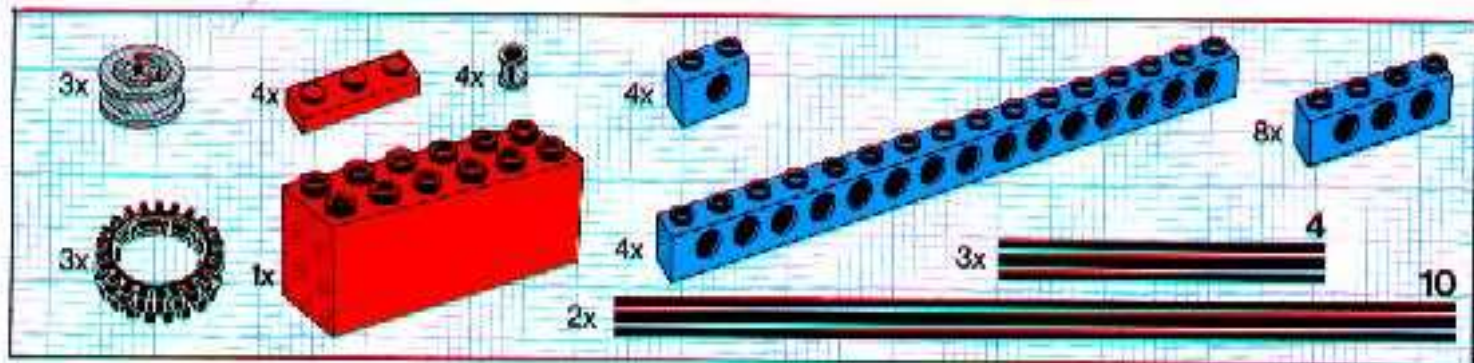

1

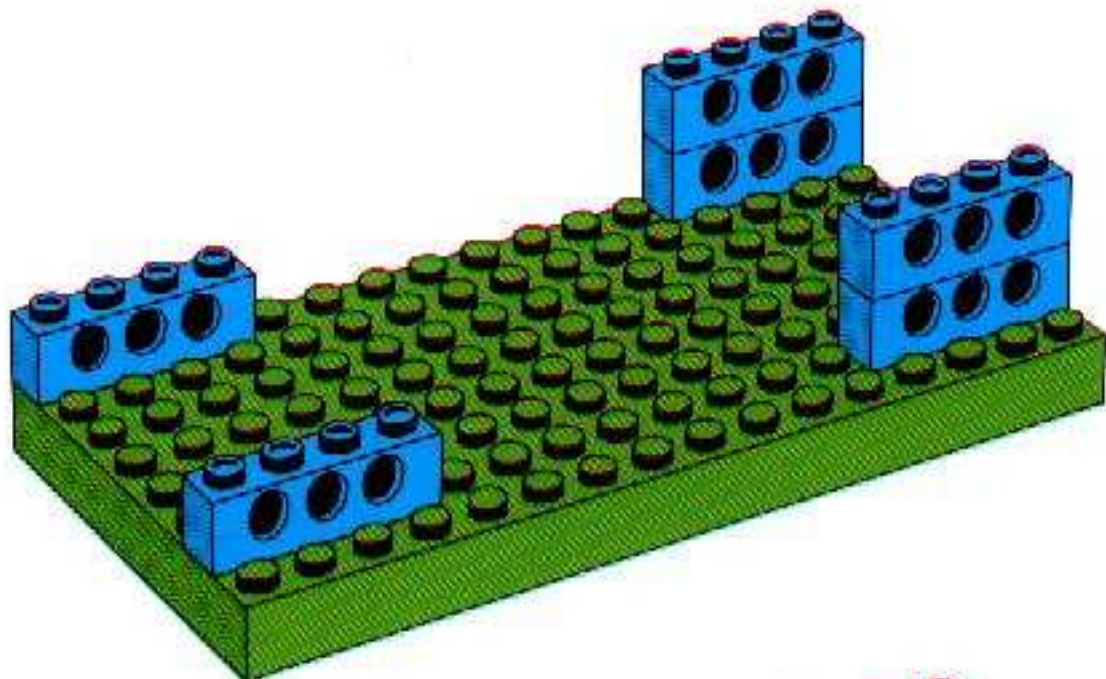

2

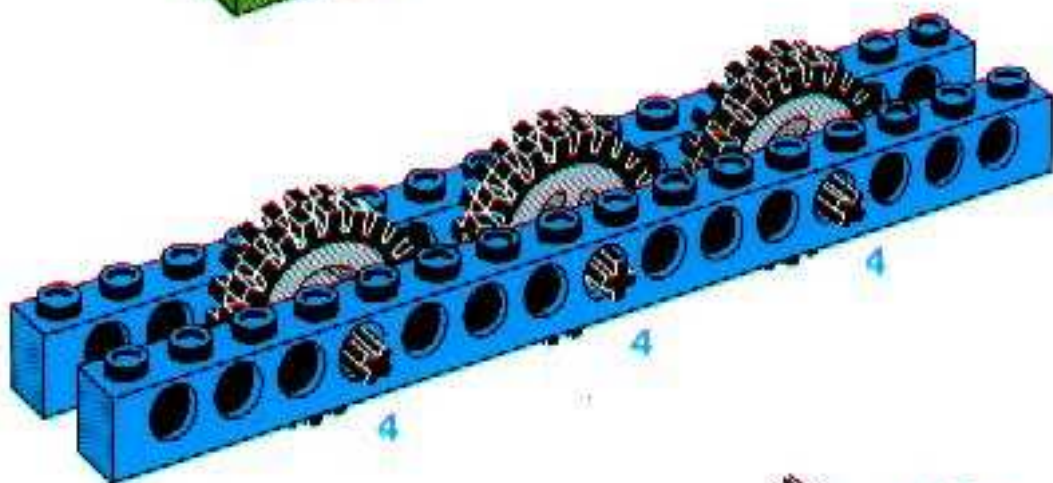

3

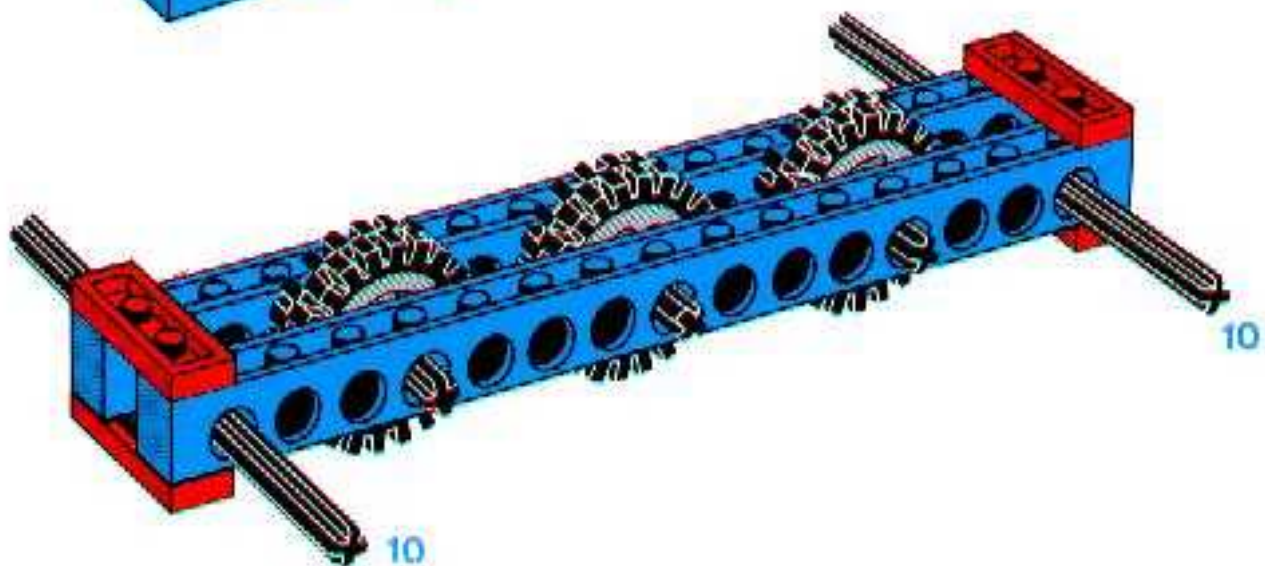

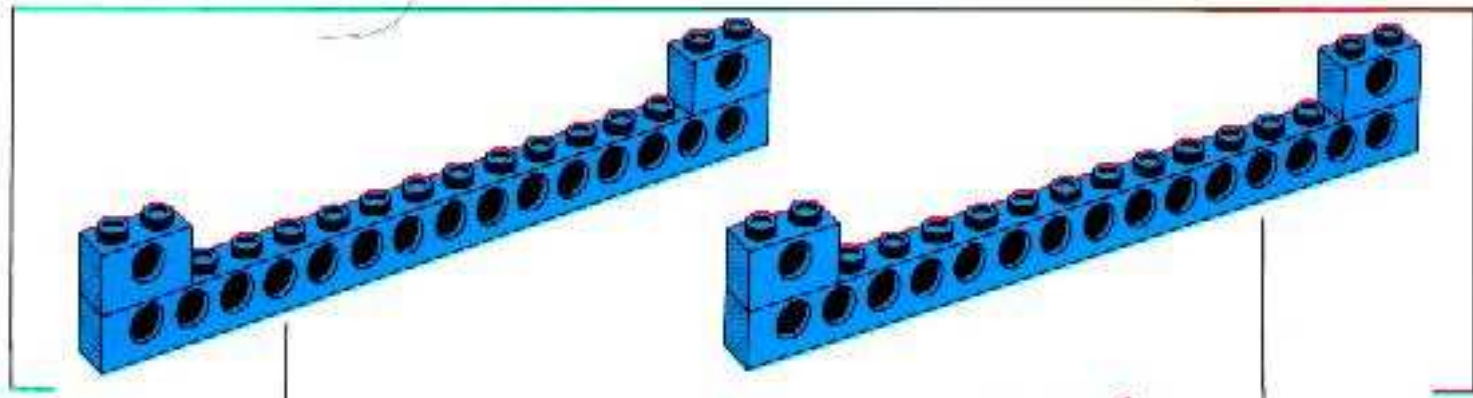

④

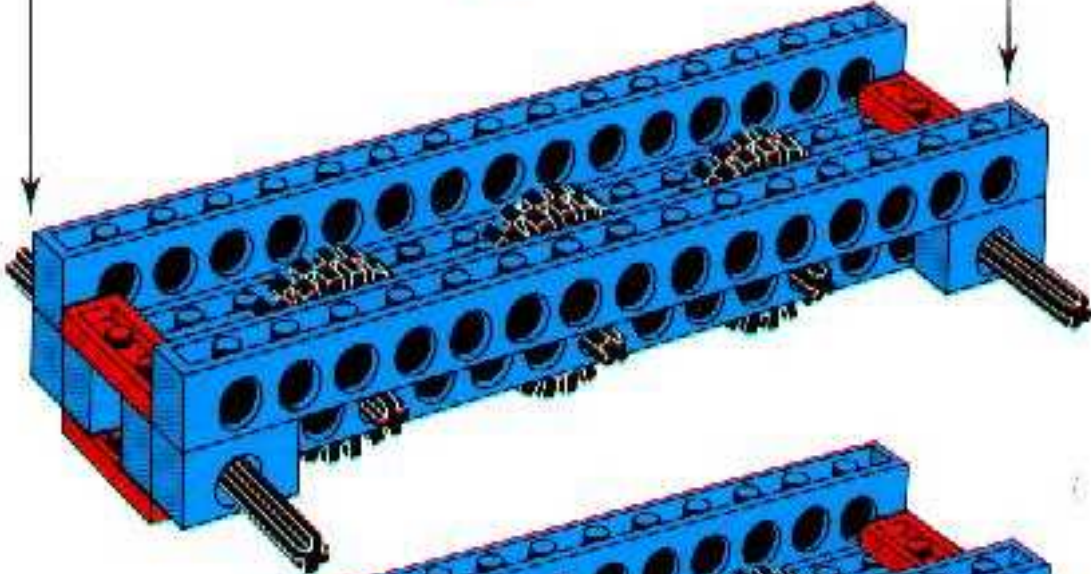

⑤

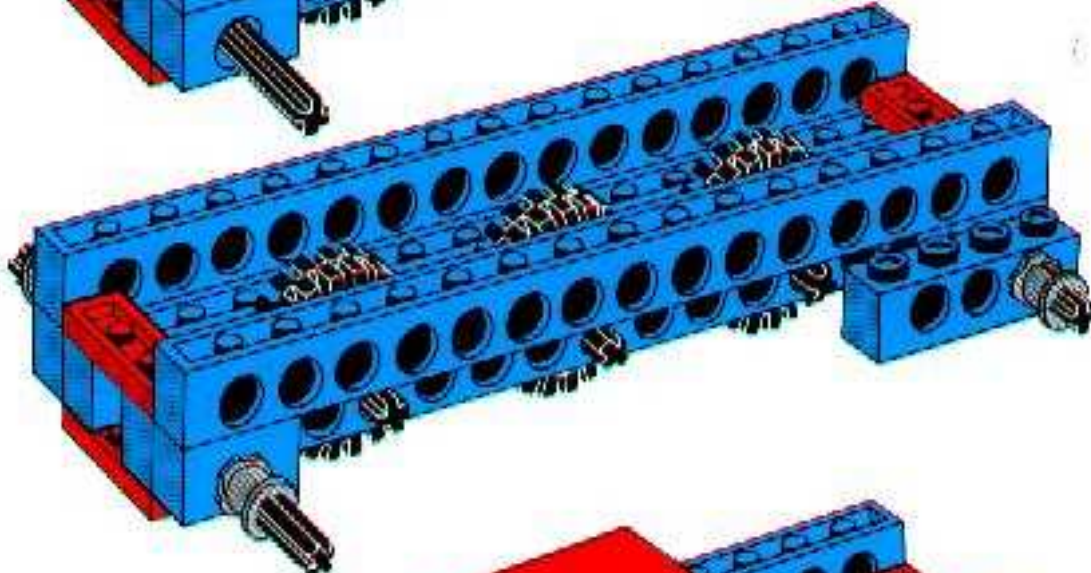

⑥

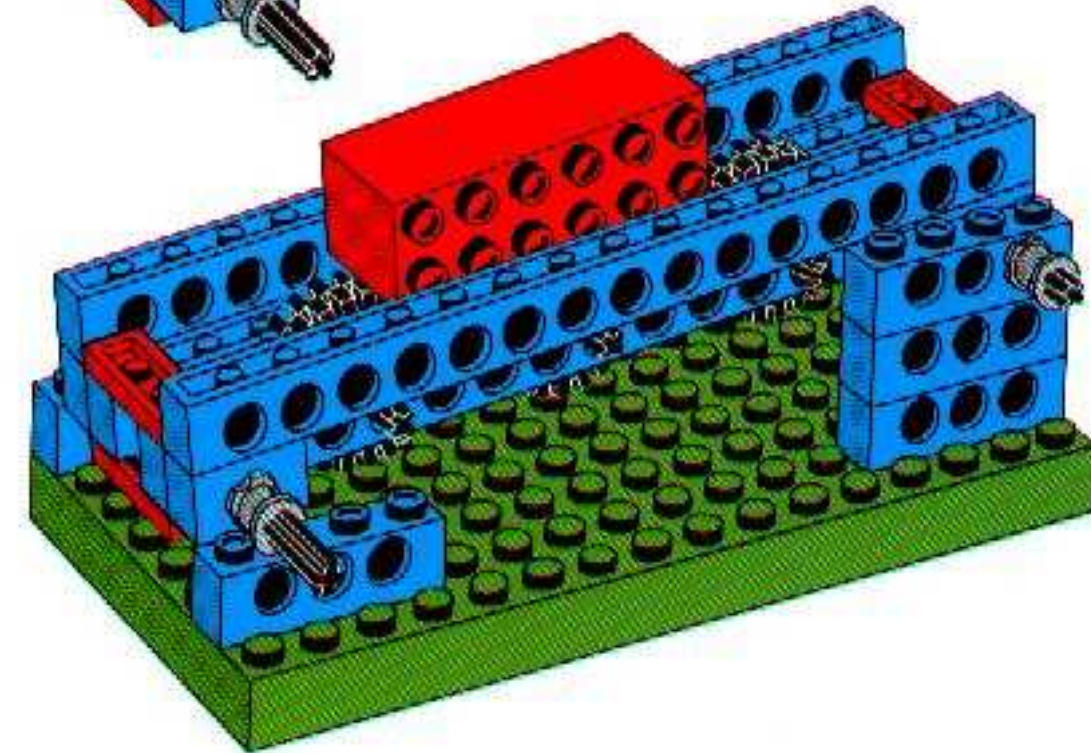

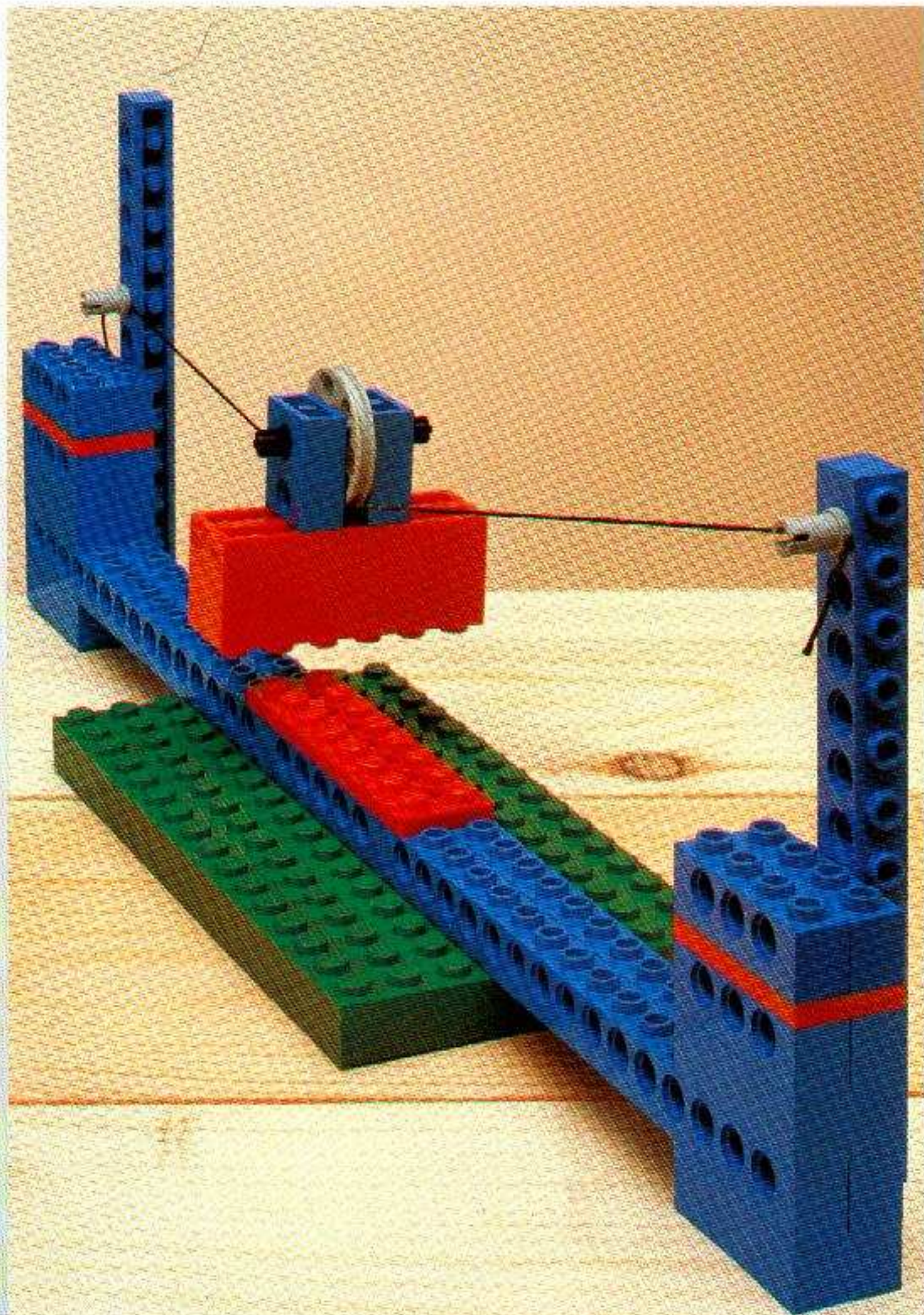



1031

12

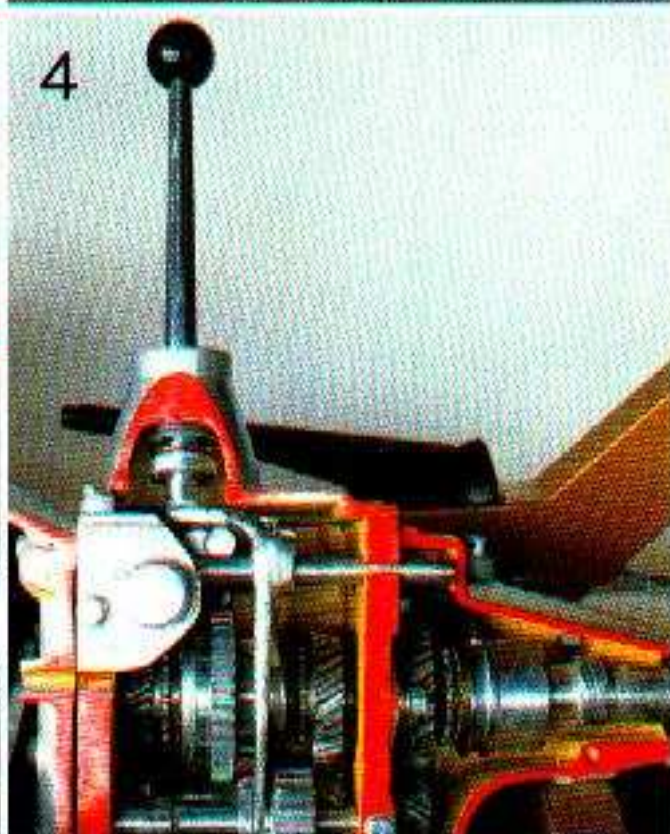
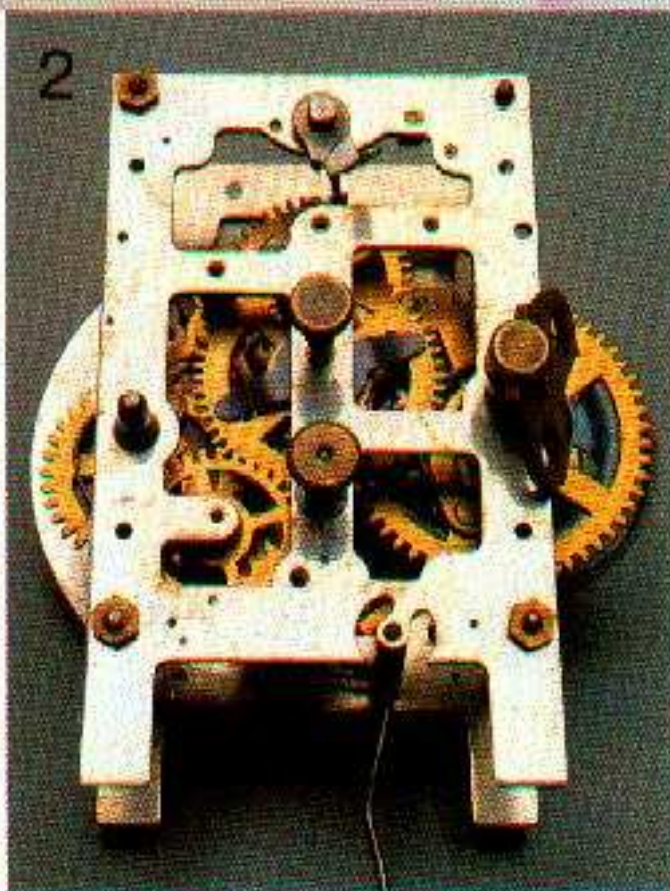

LEGO dacta

Technic

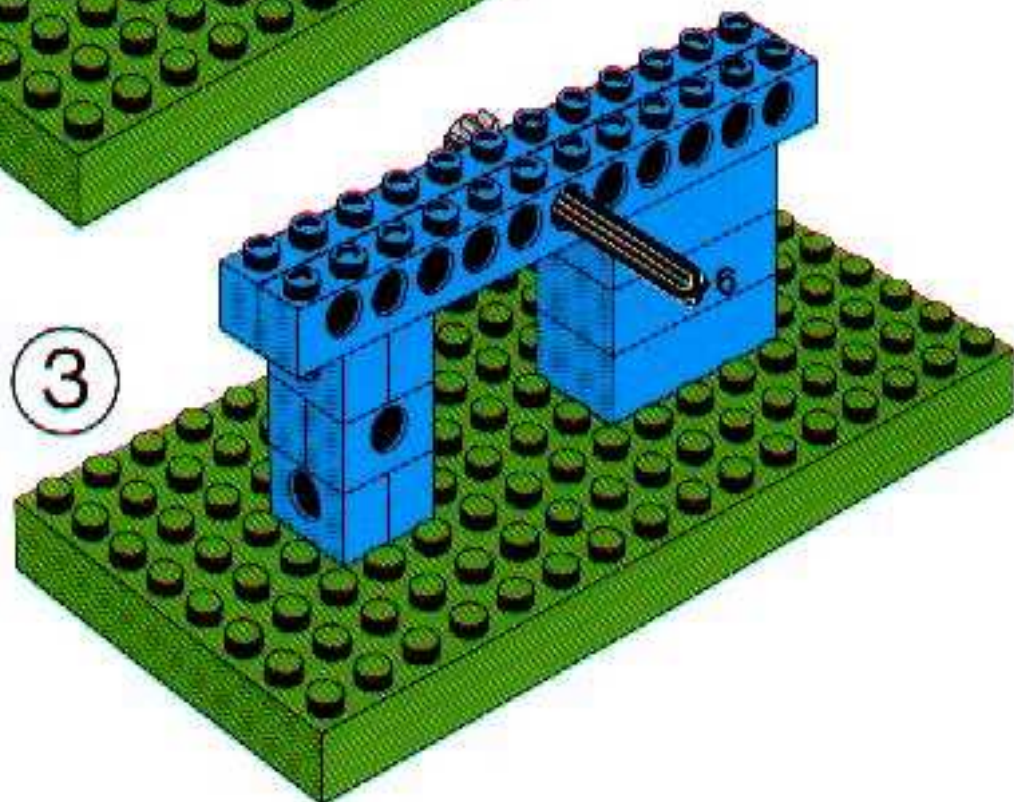
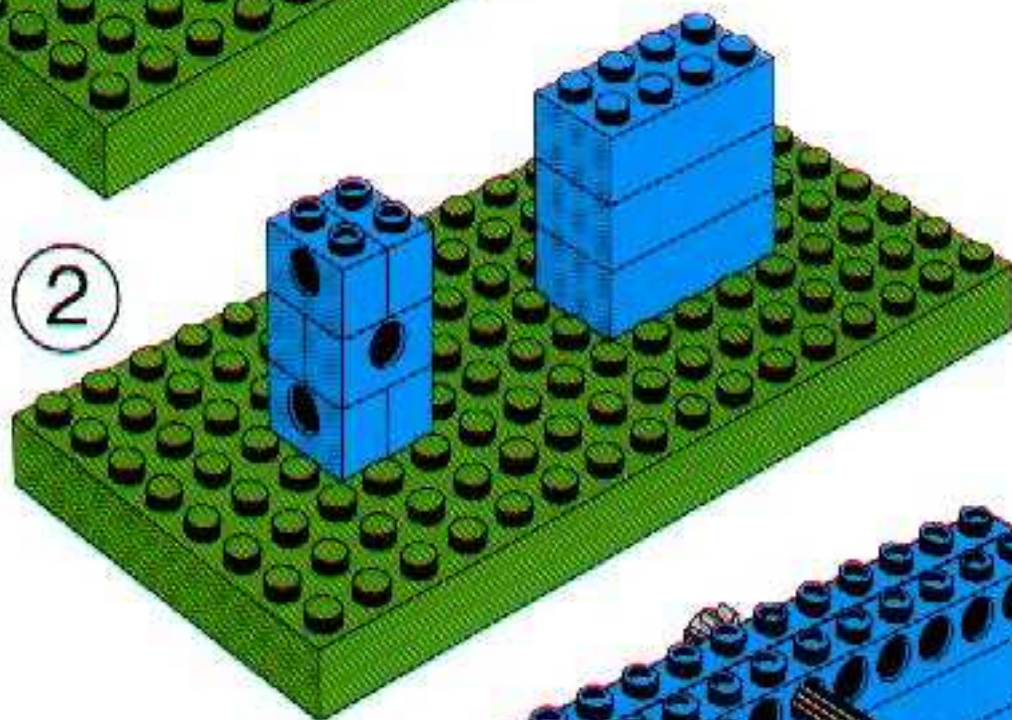
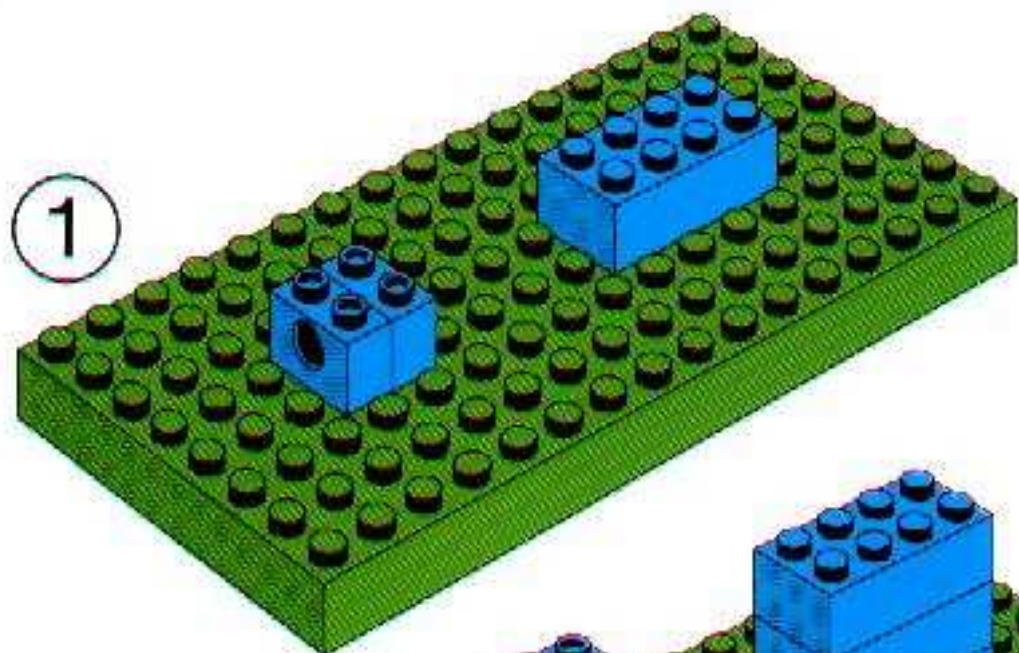
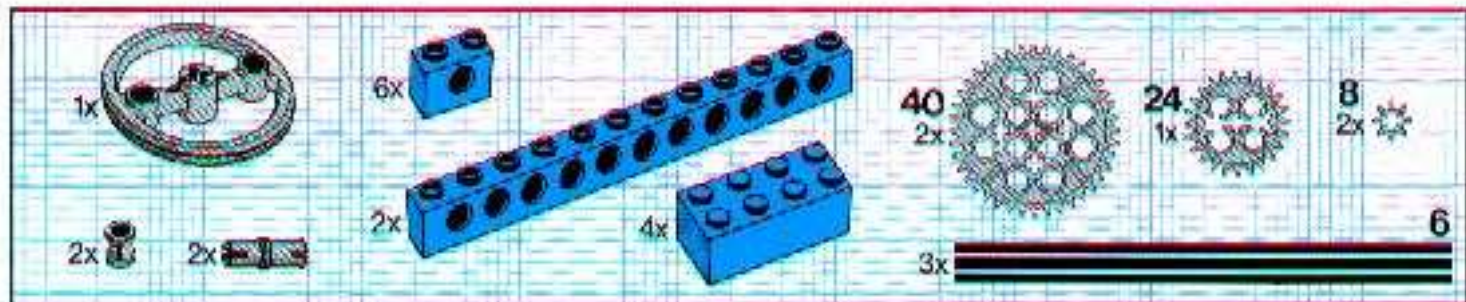

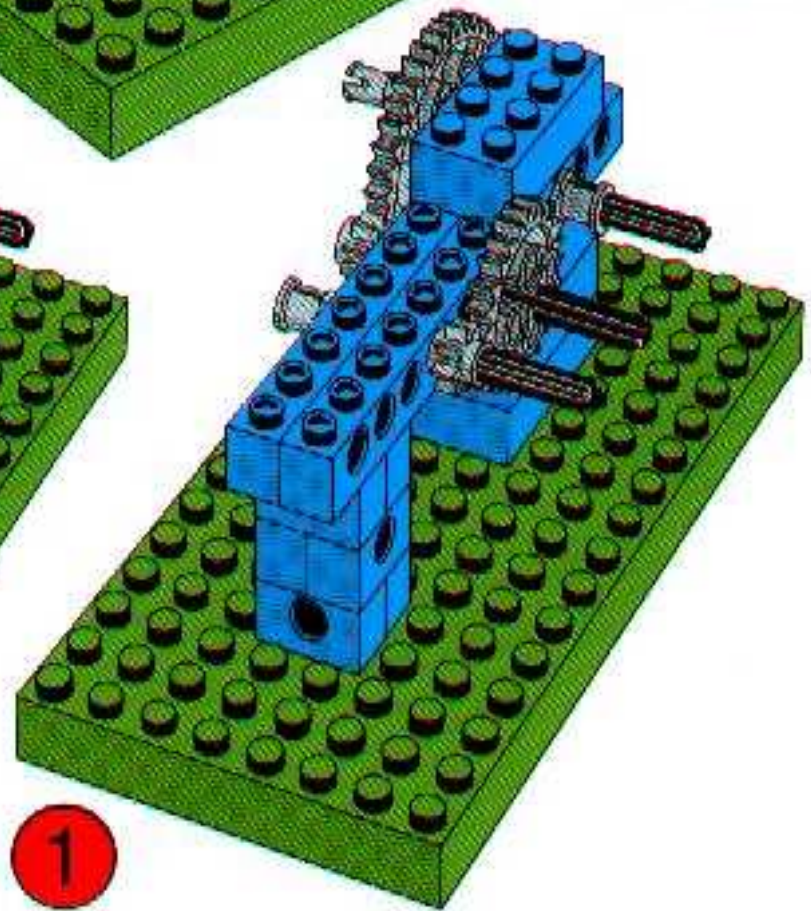
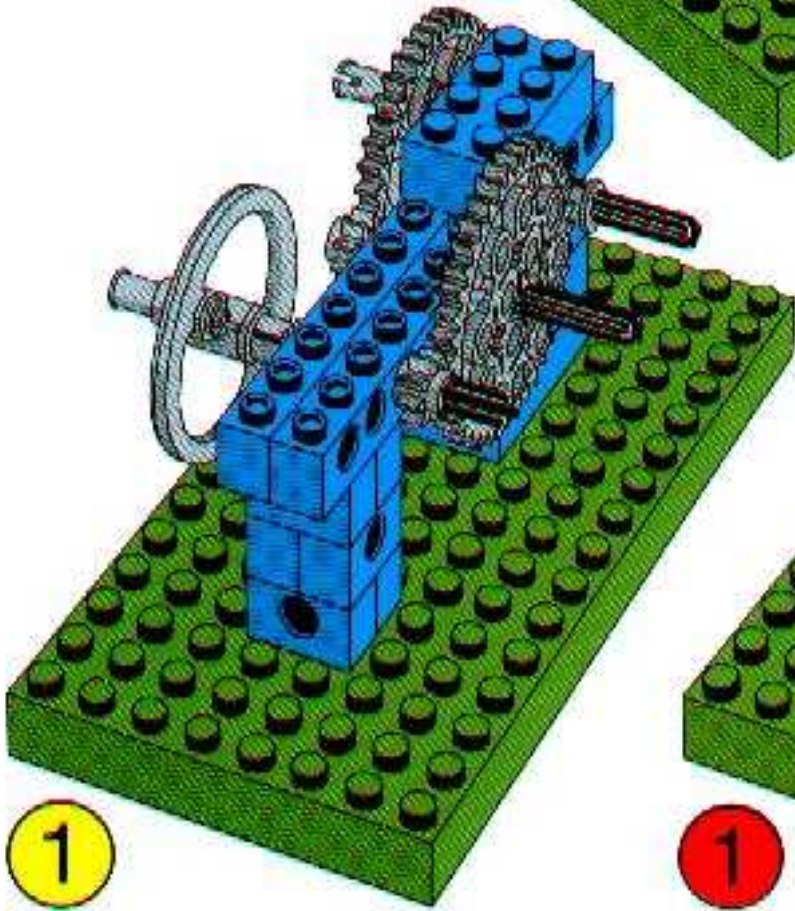
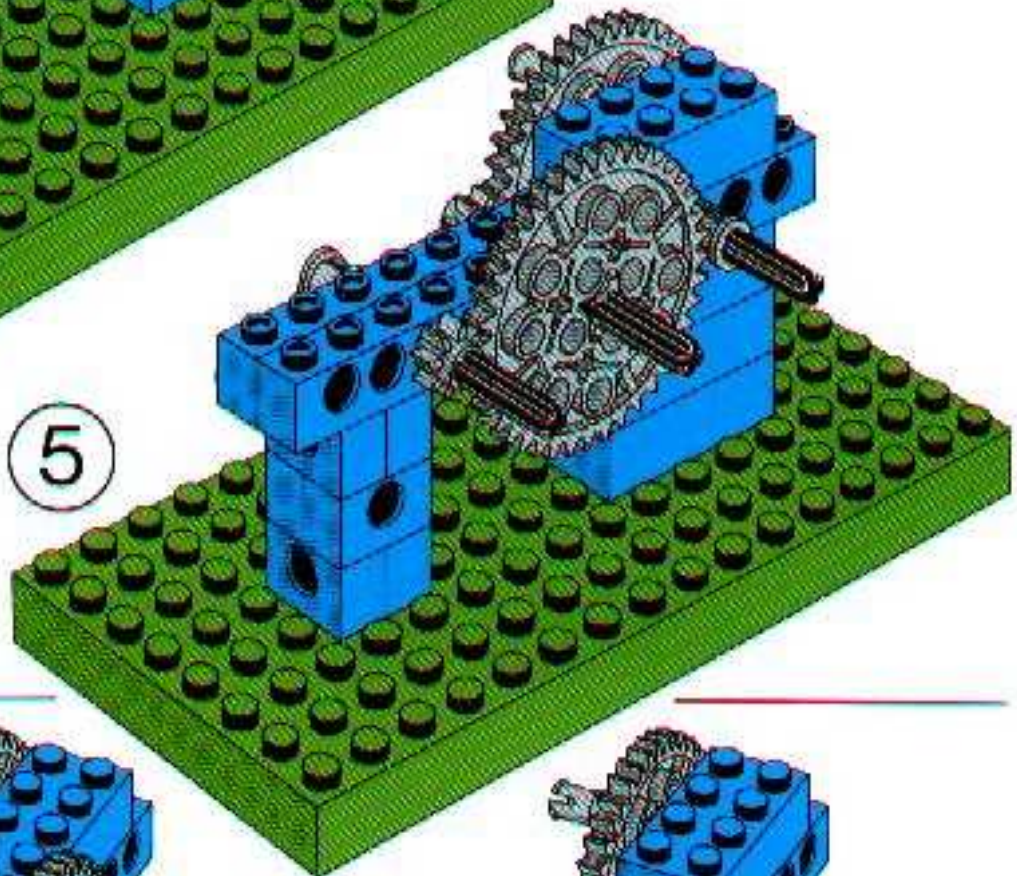
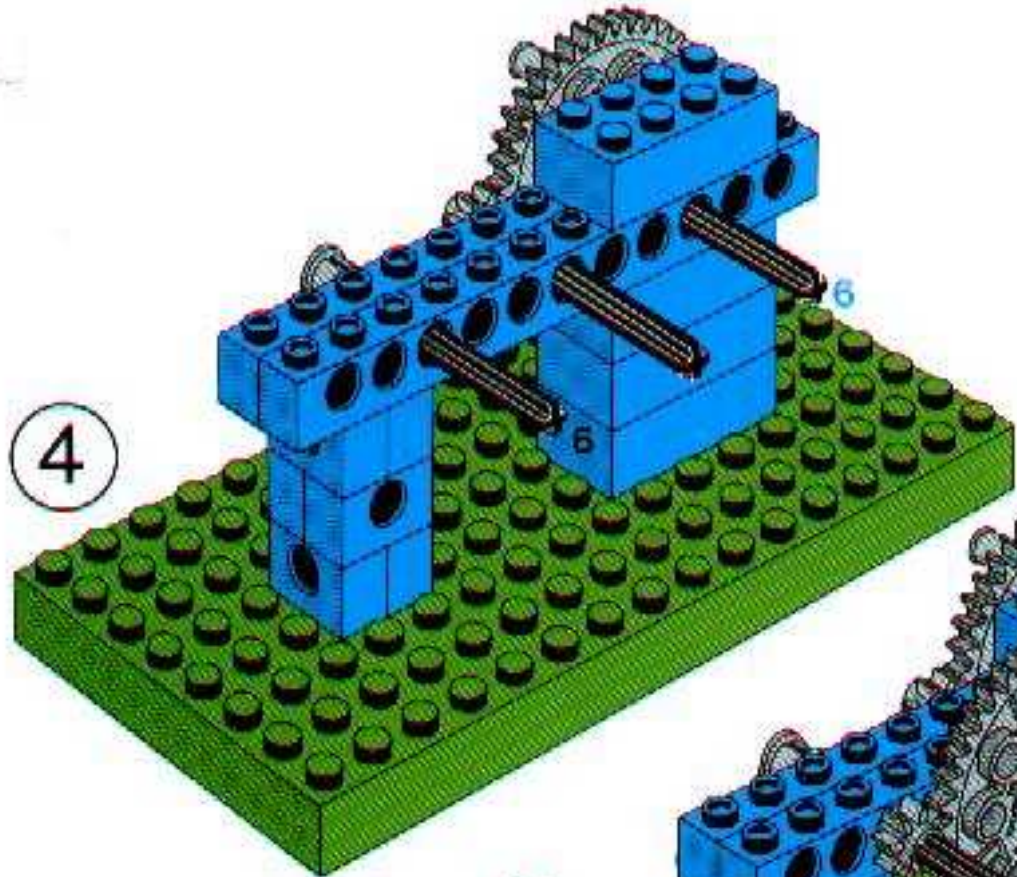

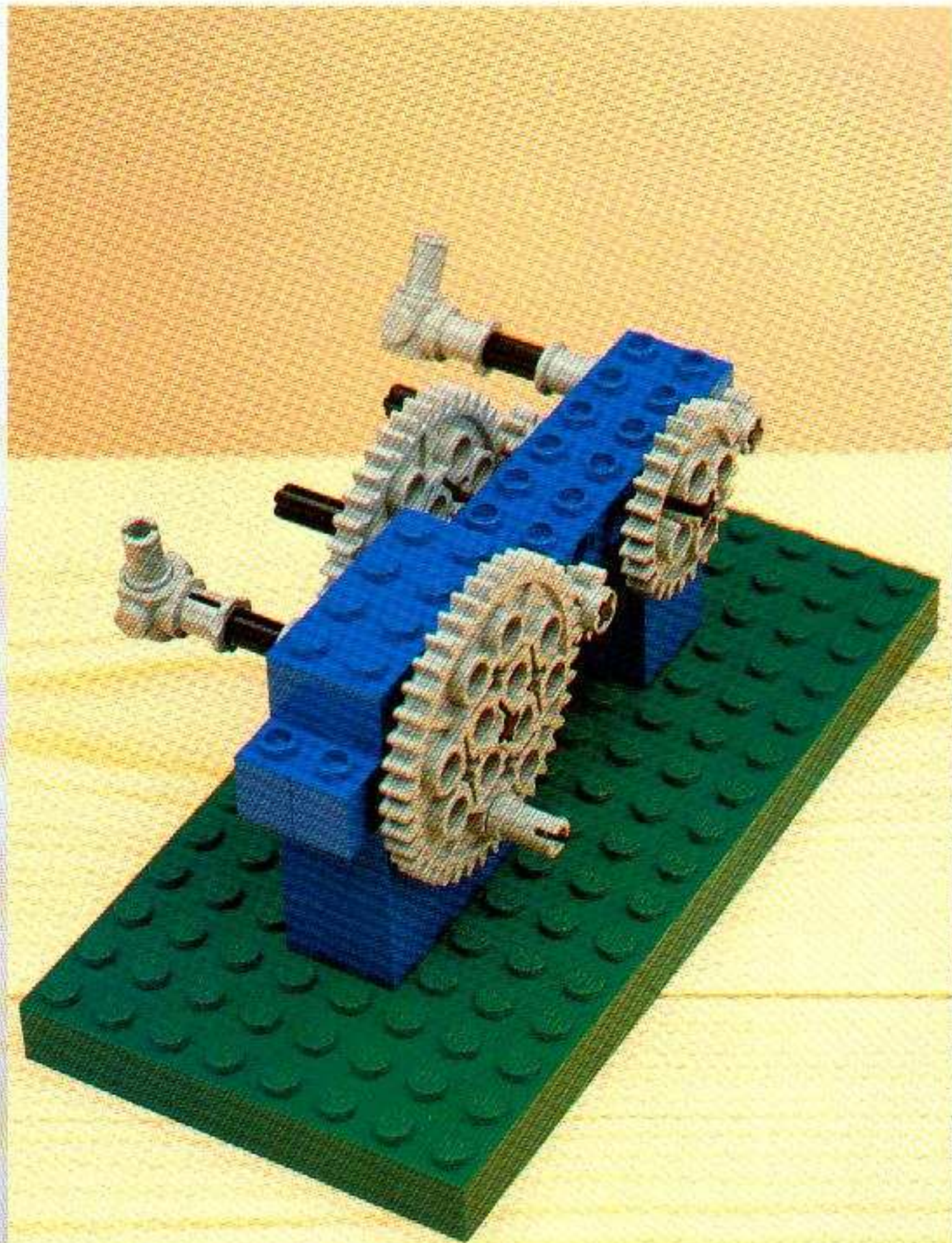



1031

13

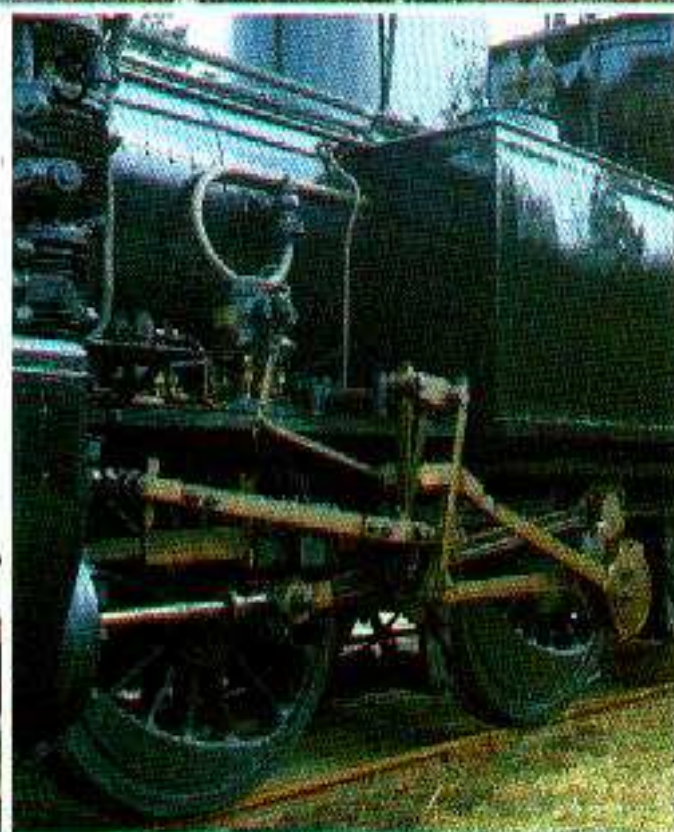
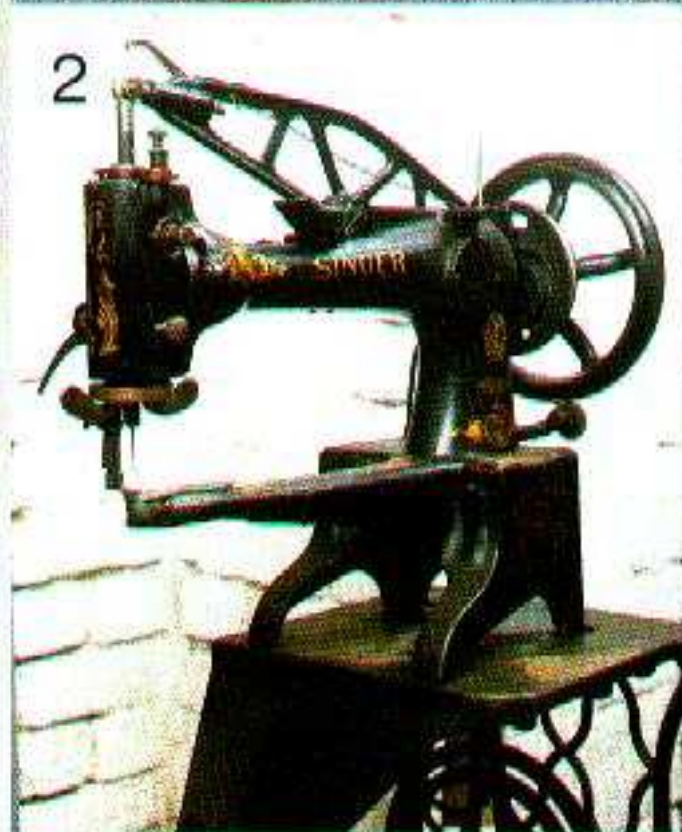

LEGO dacta

Technic

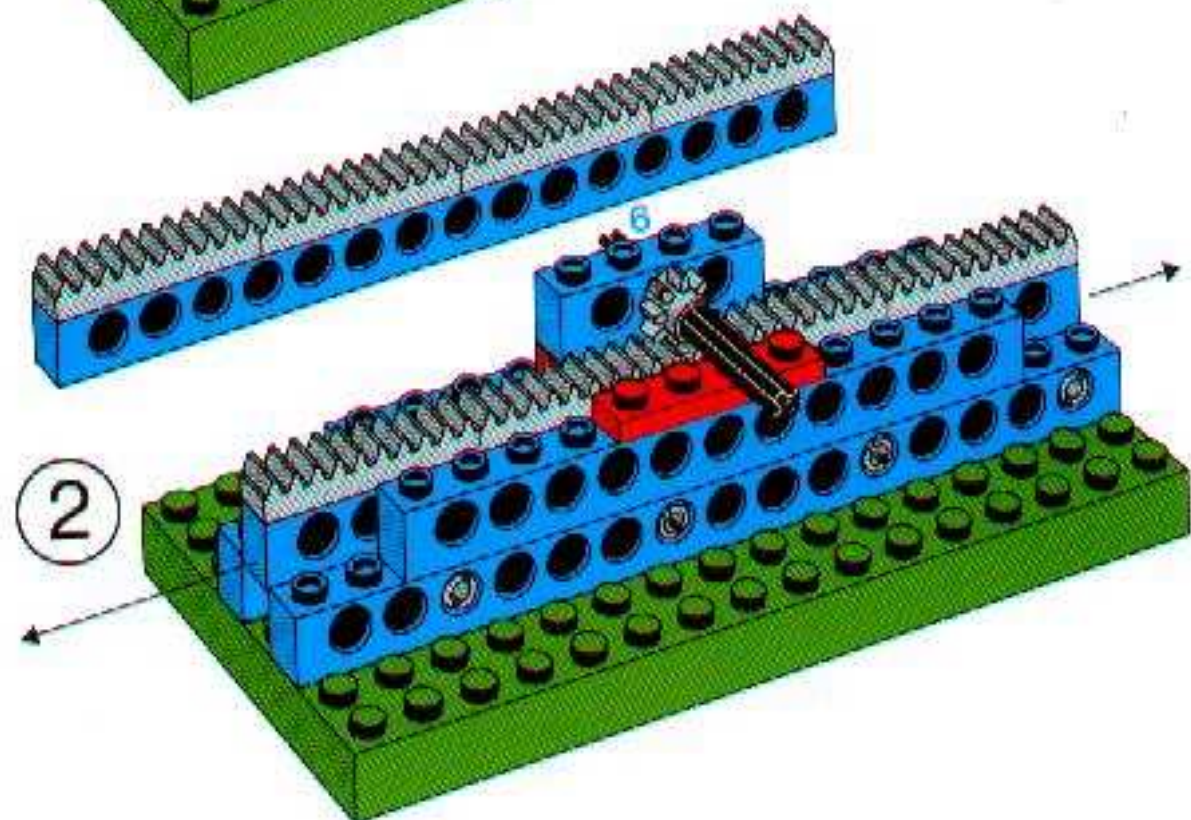
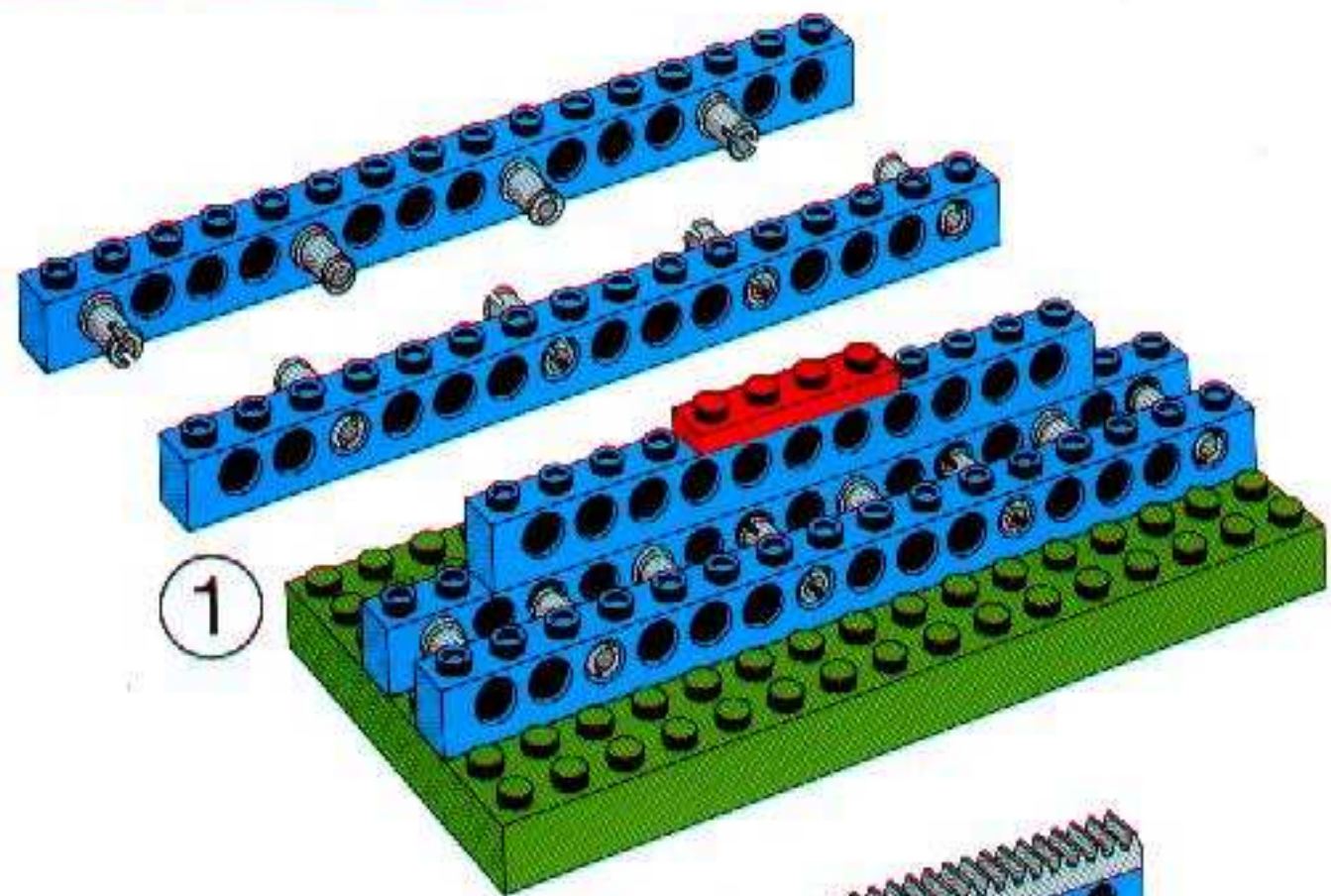
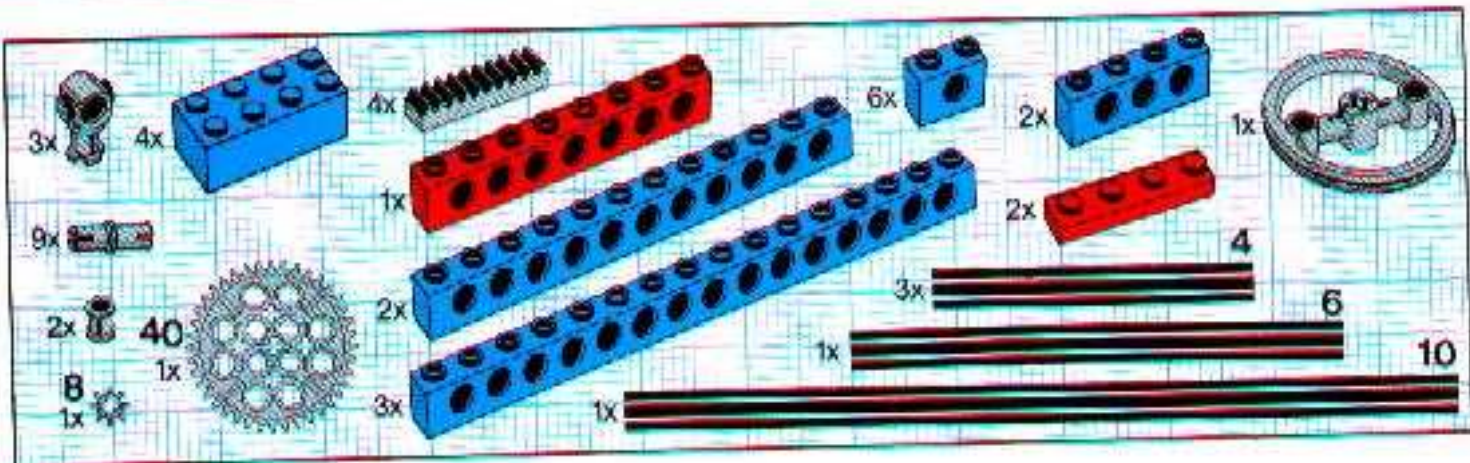

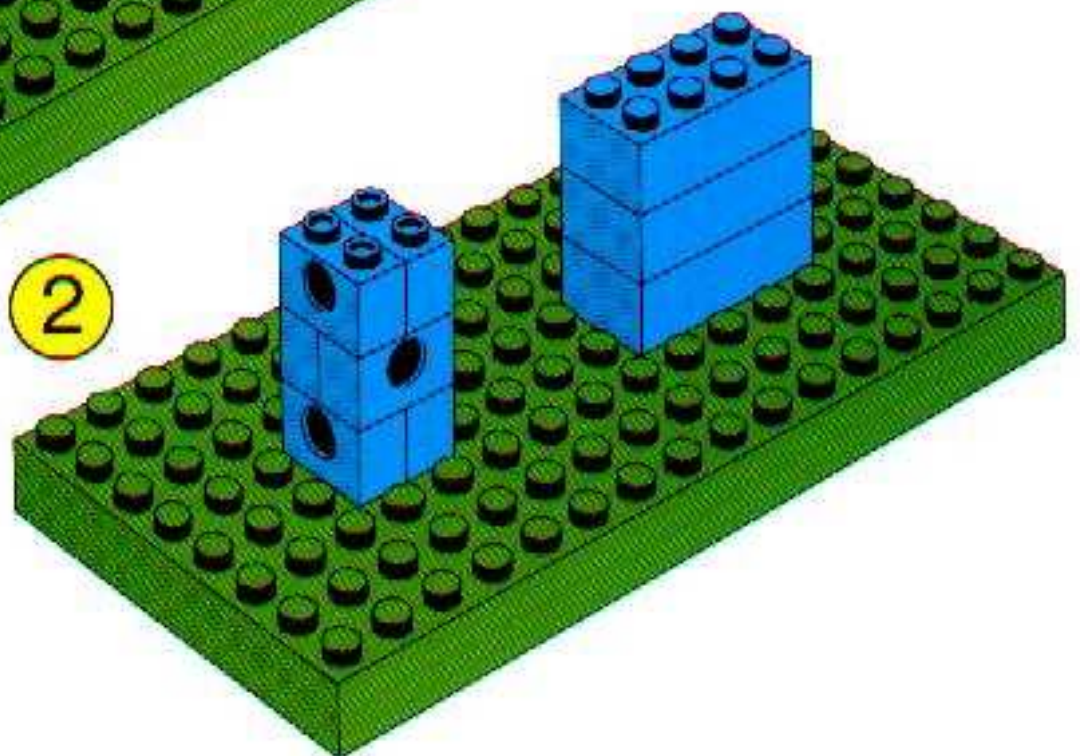
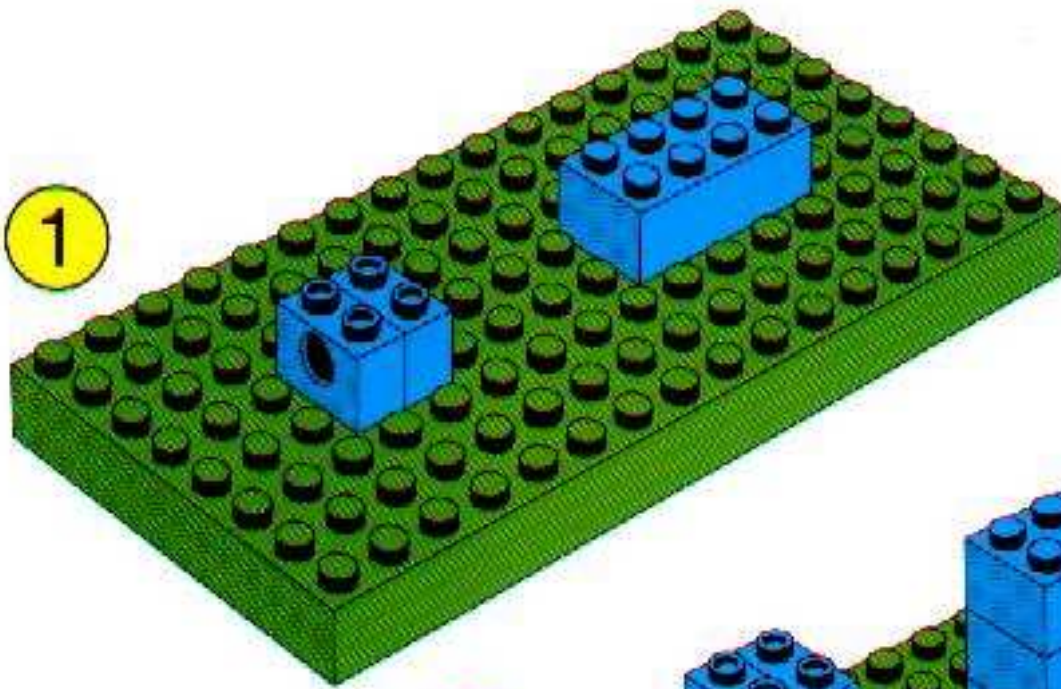
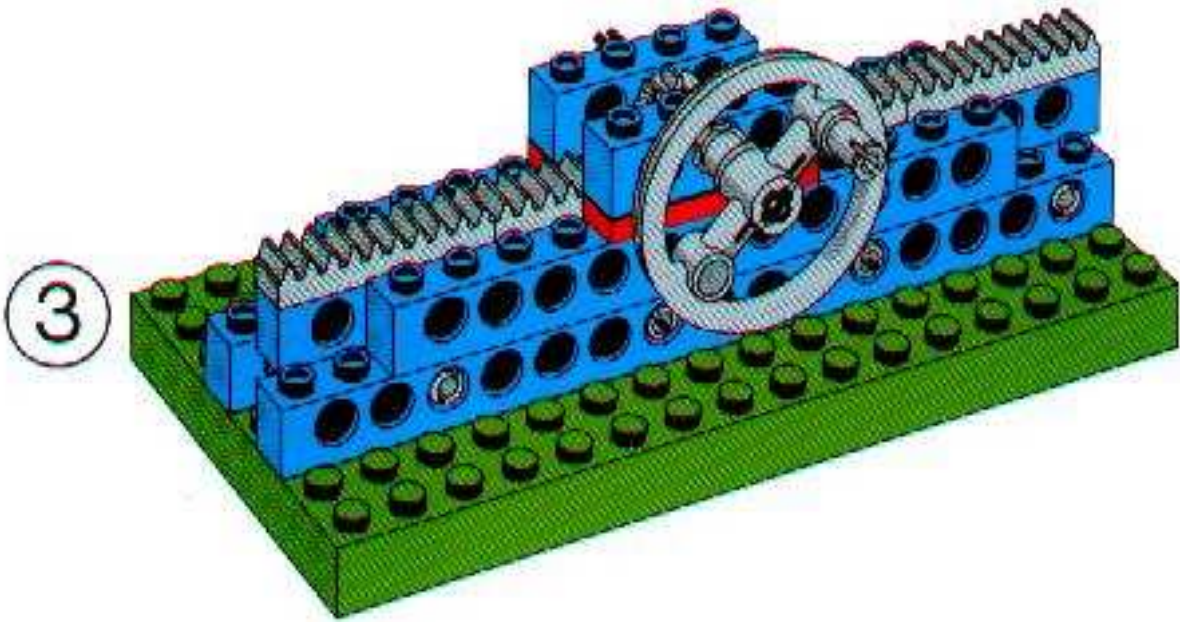

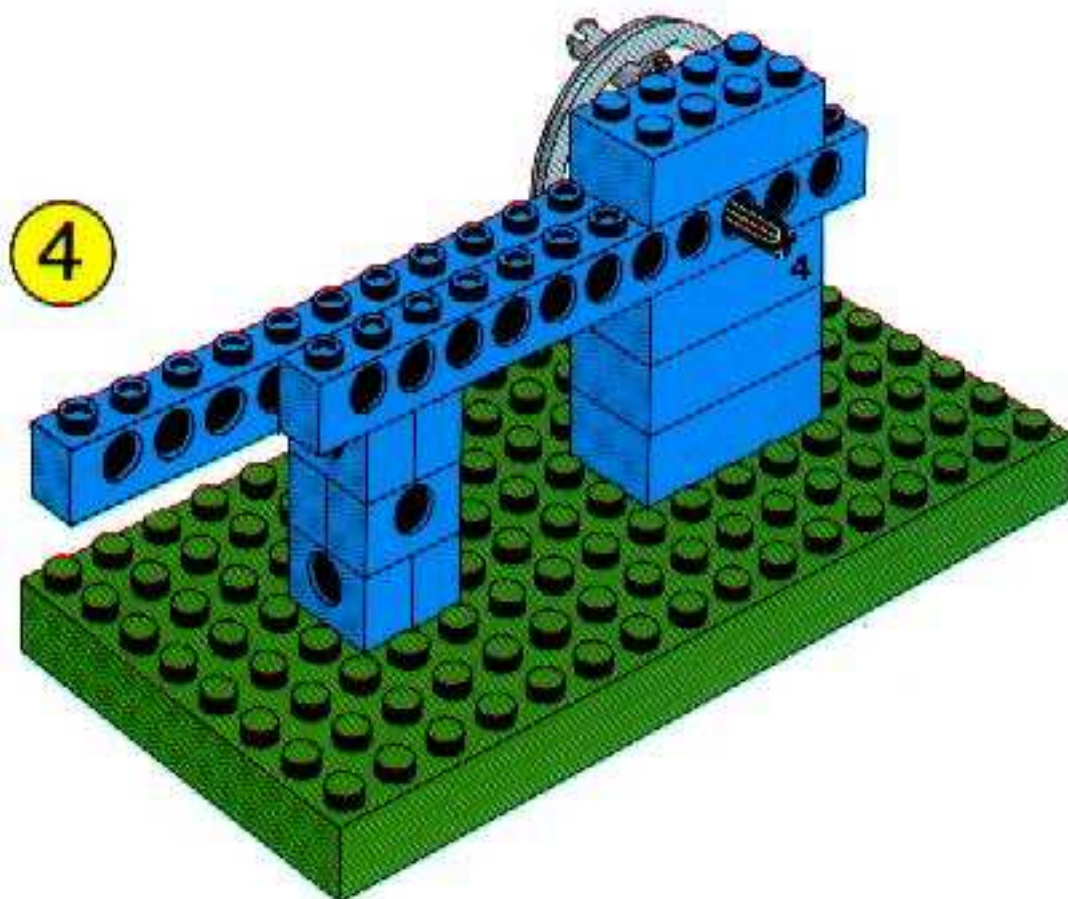
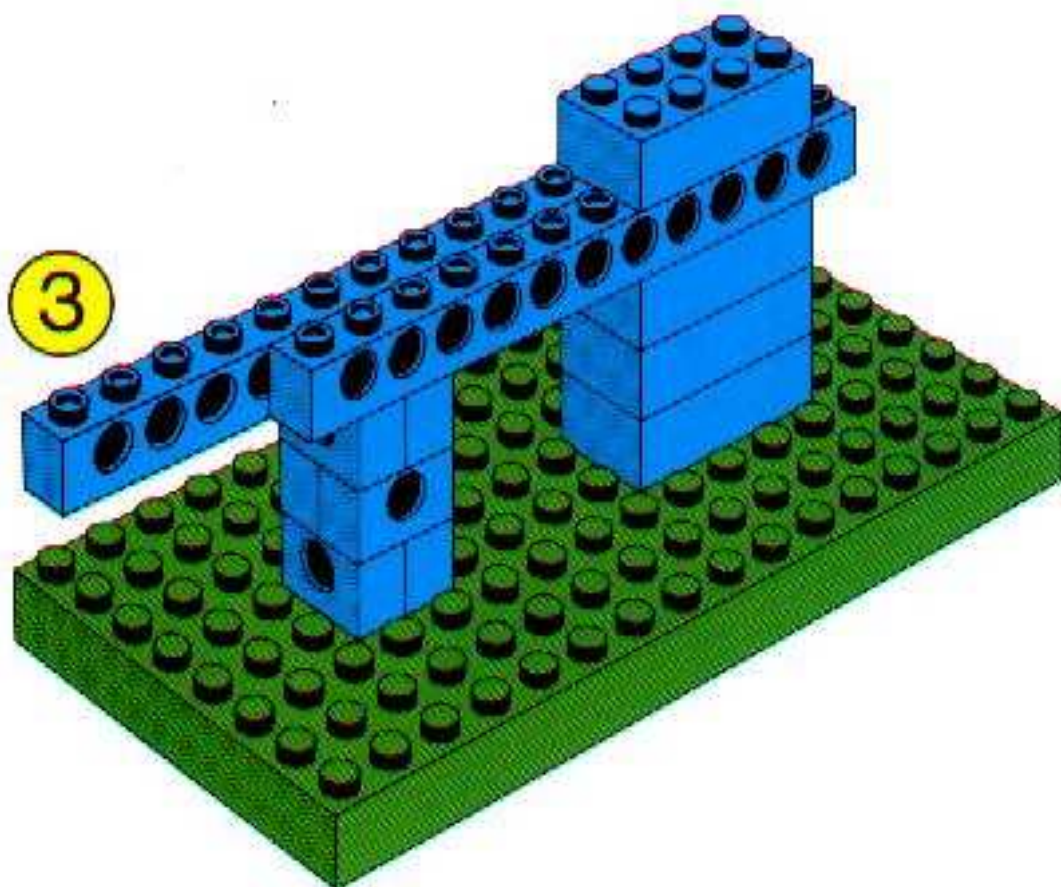

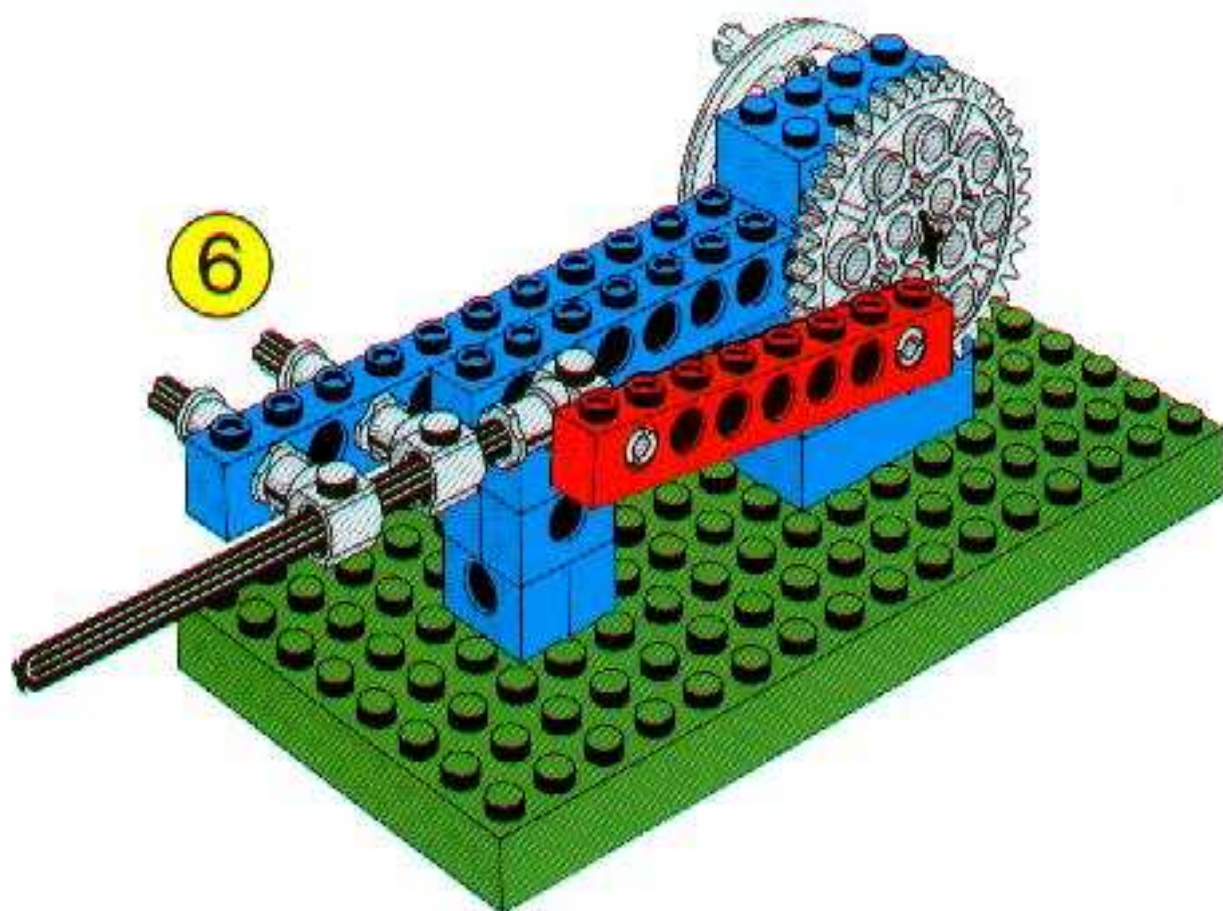
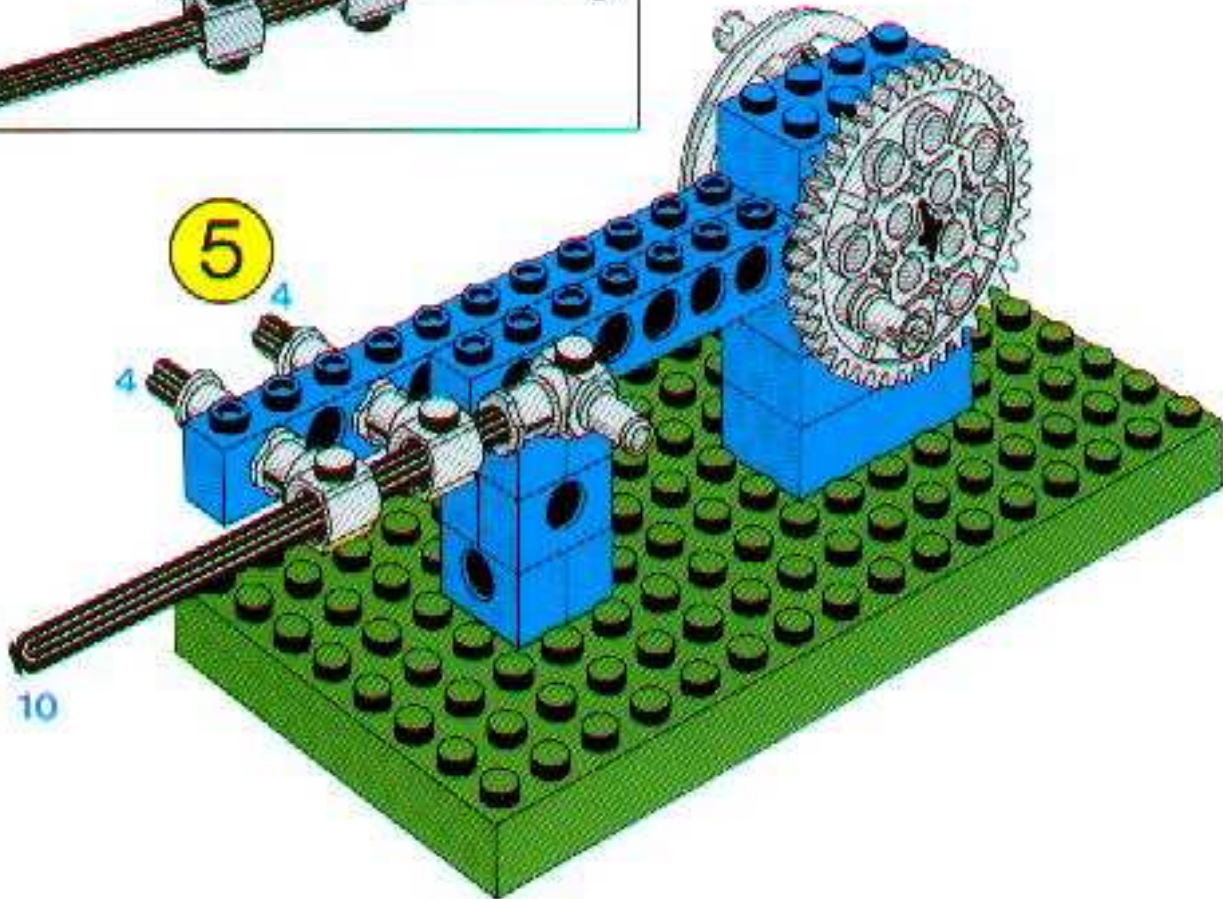
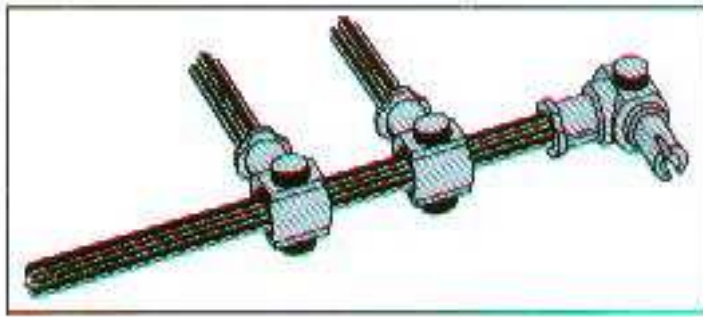

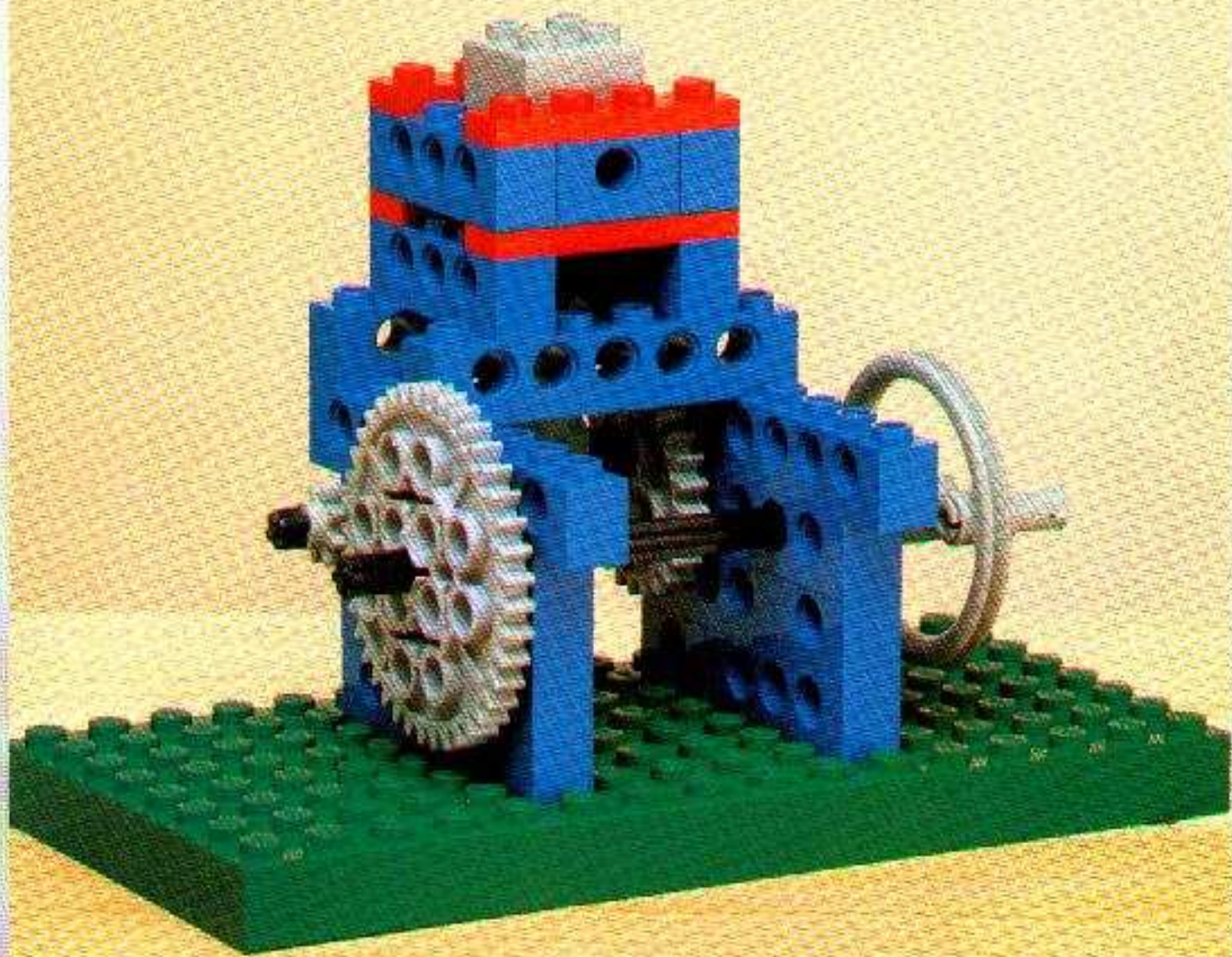
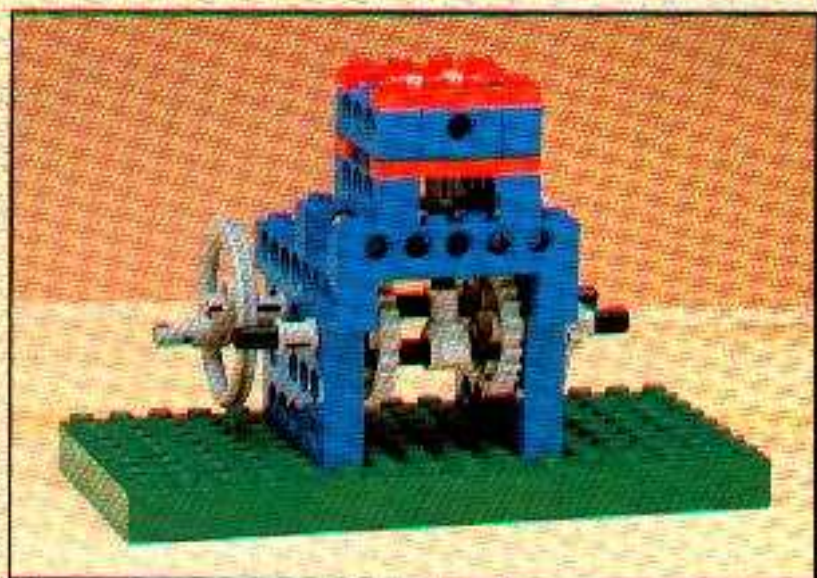



1031

14

1



2



3



 **dacta**

Technic

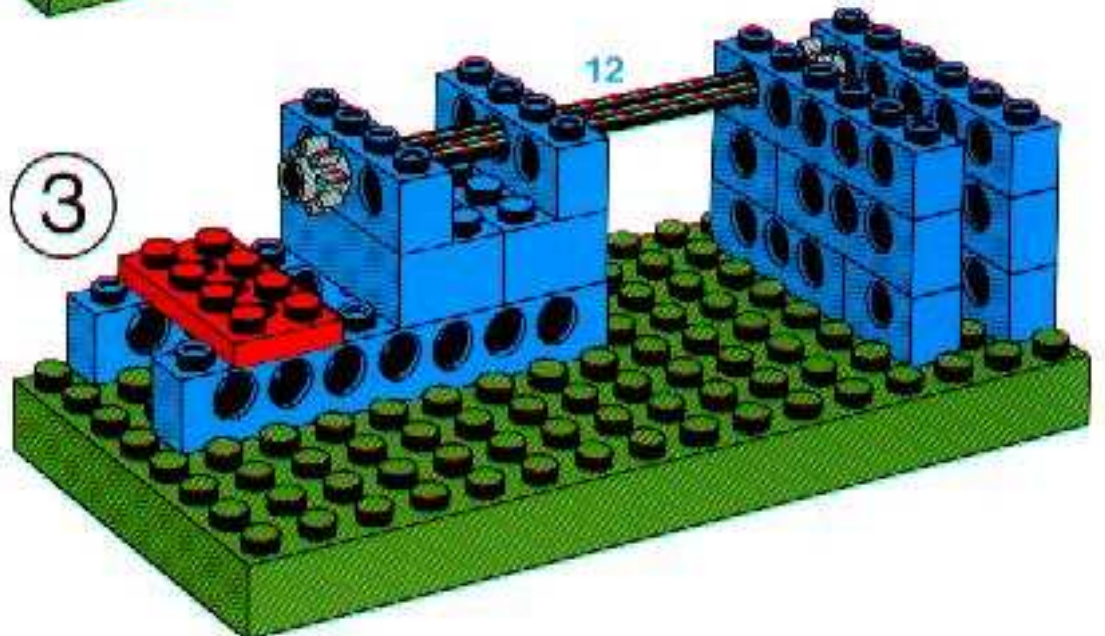
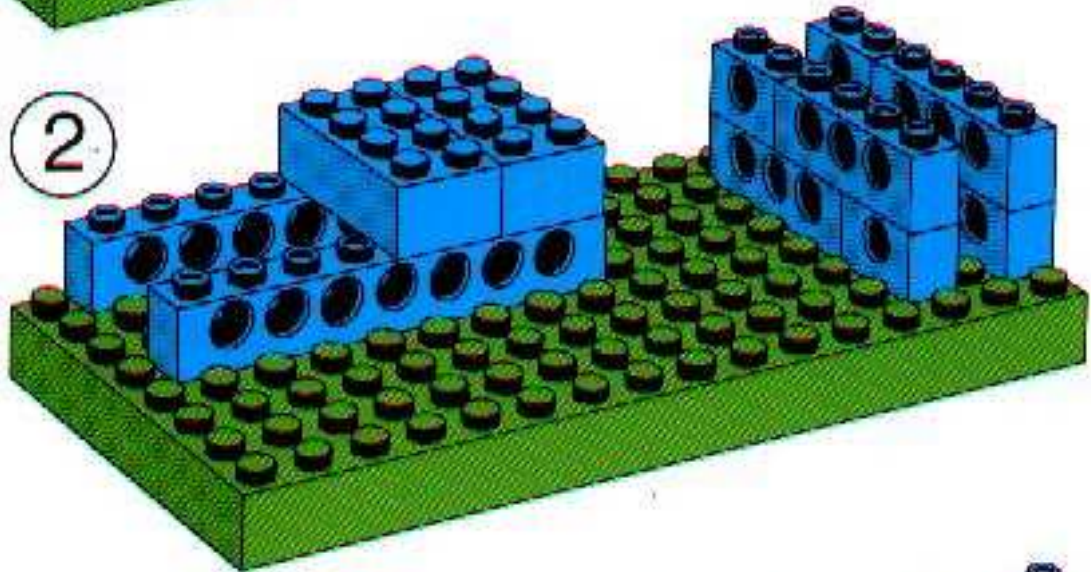
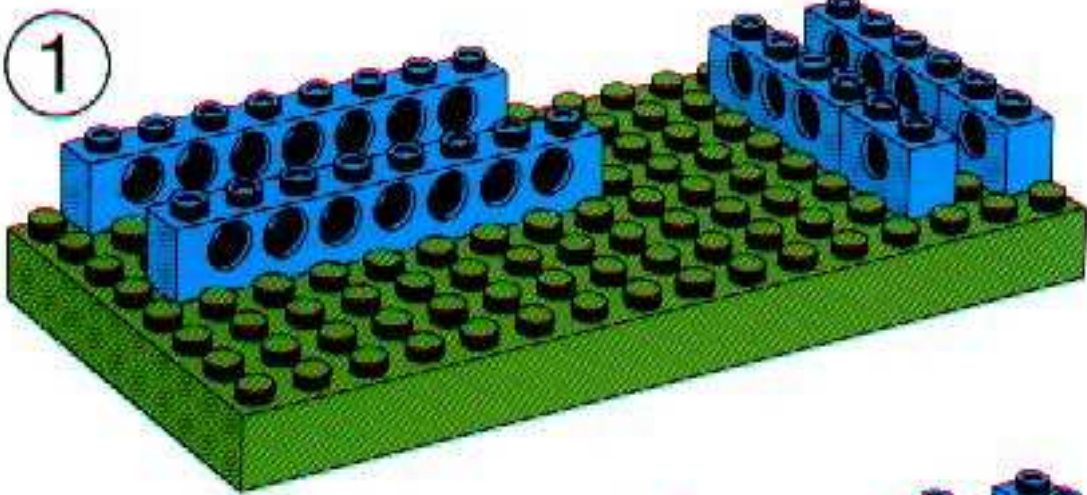
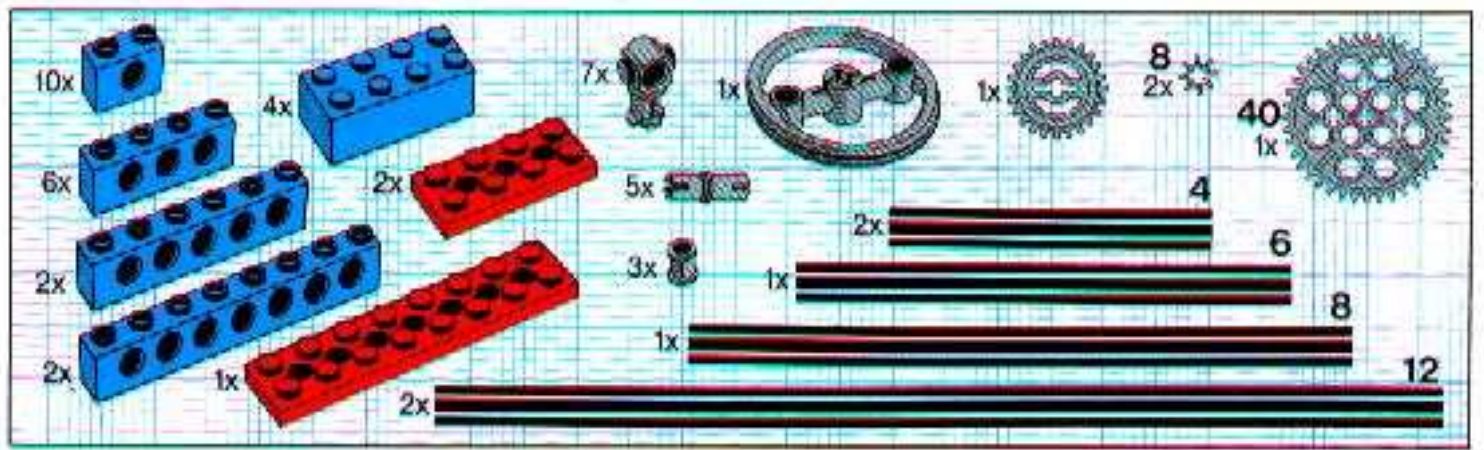

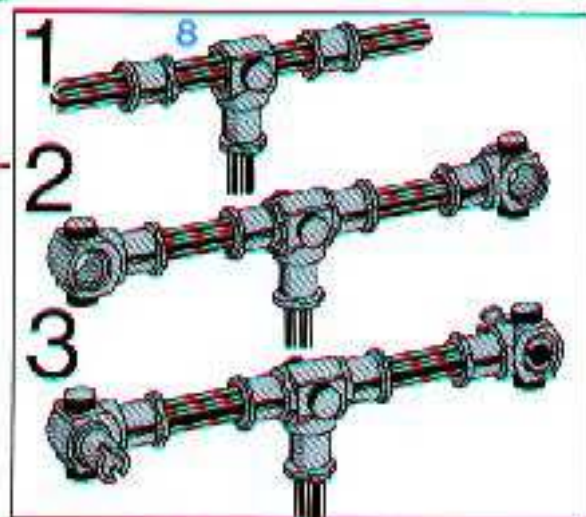
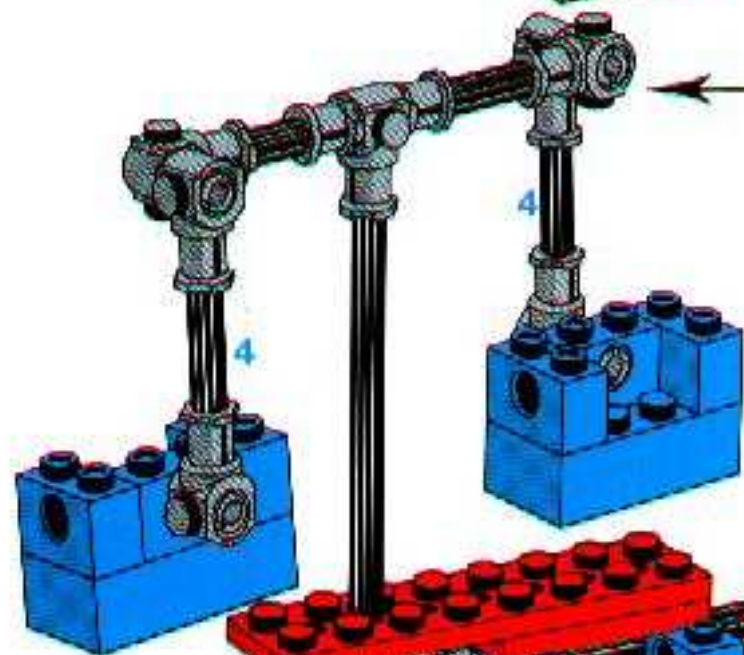
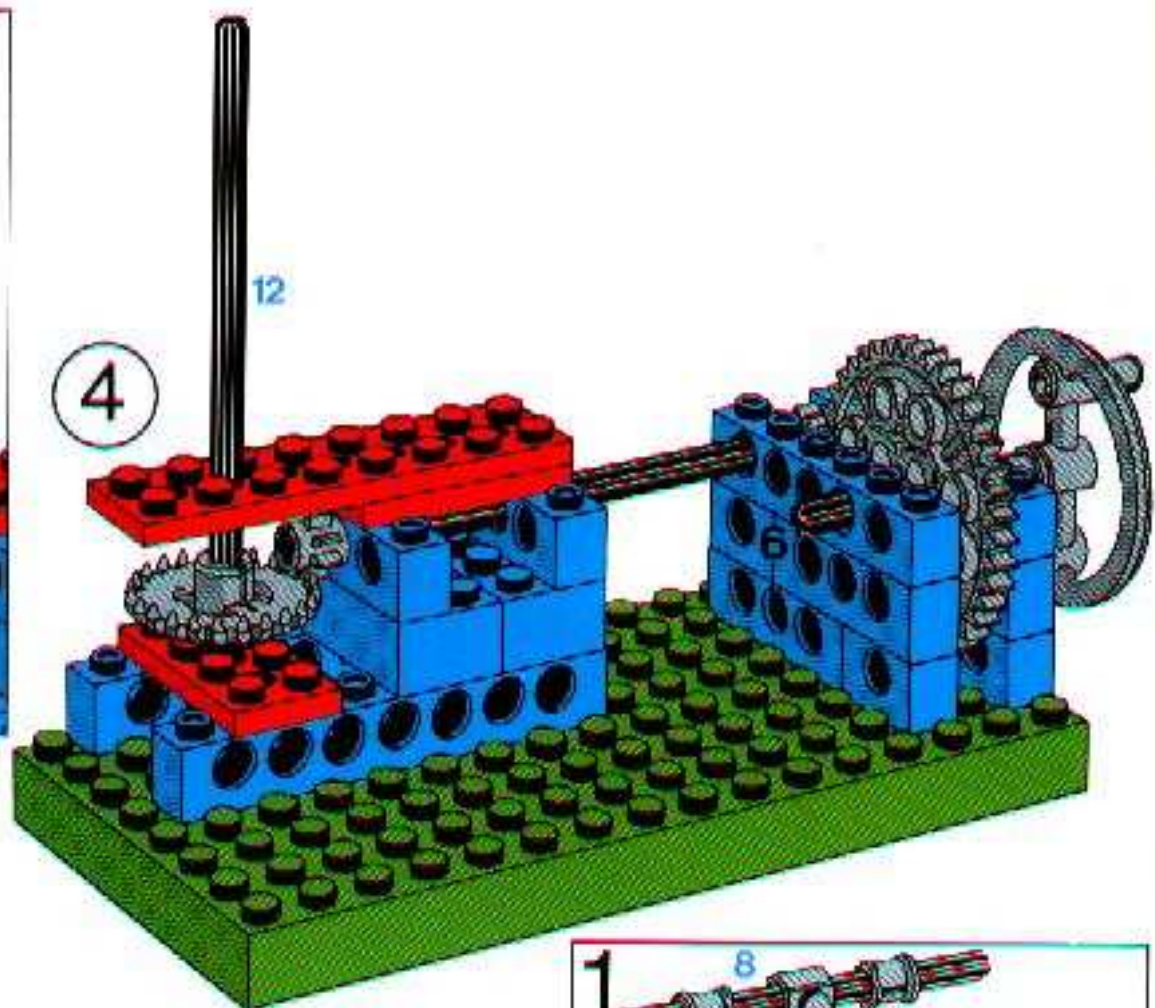
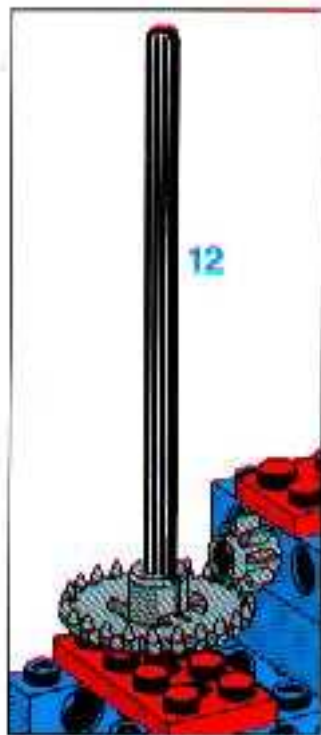

5

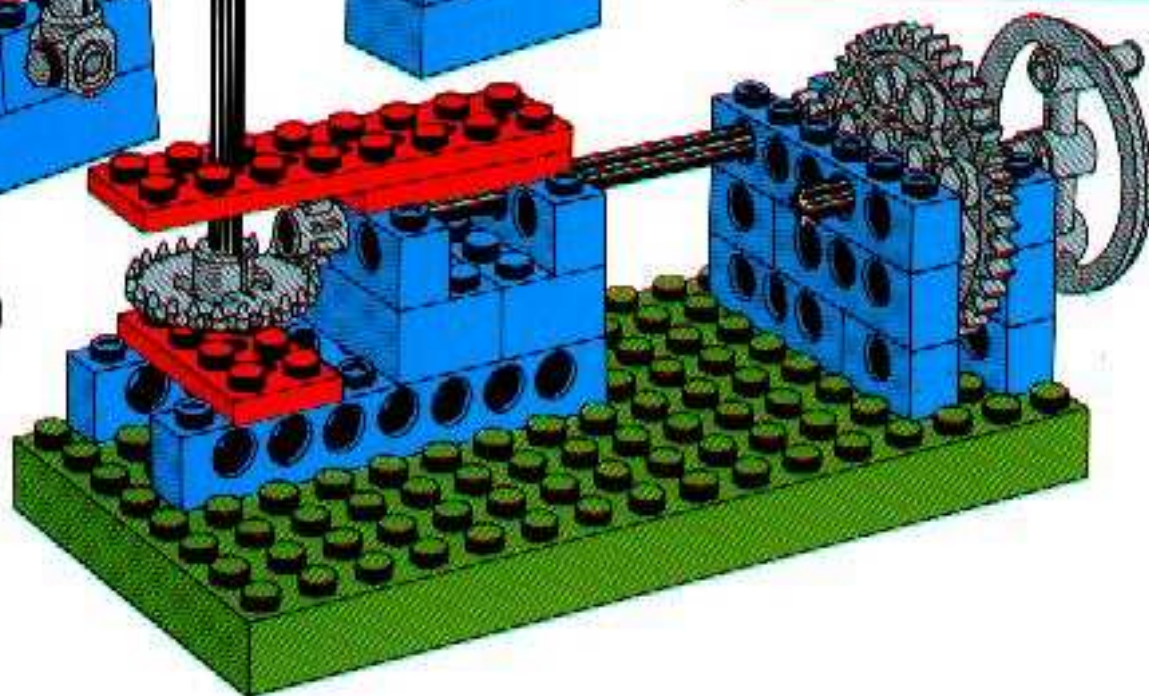

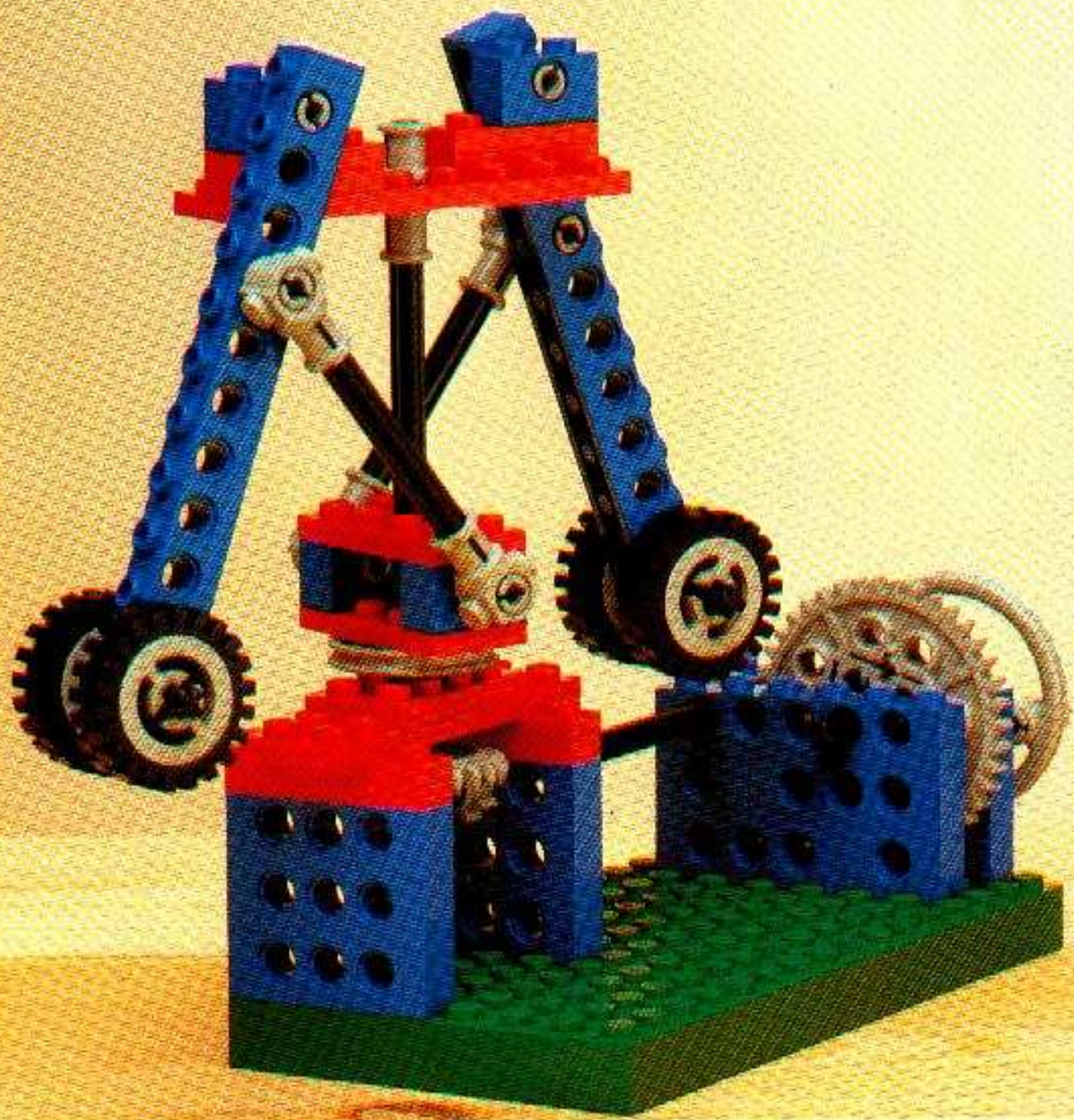

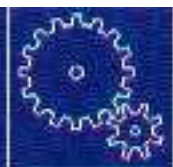

1031

15

1



2



3



LEGO dacta

Technic

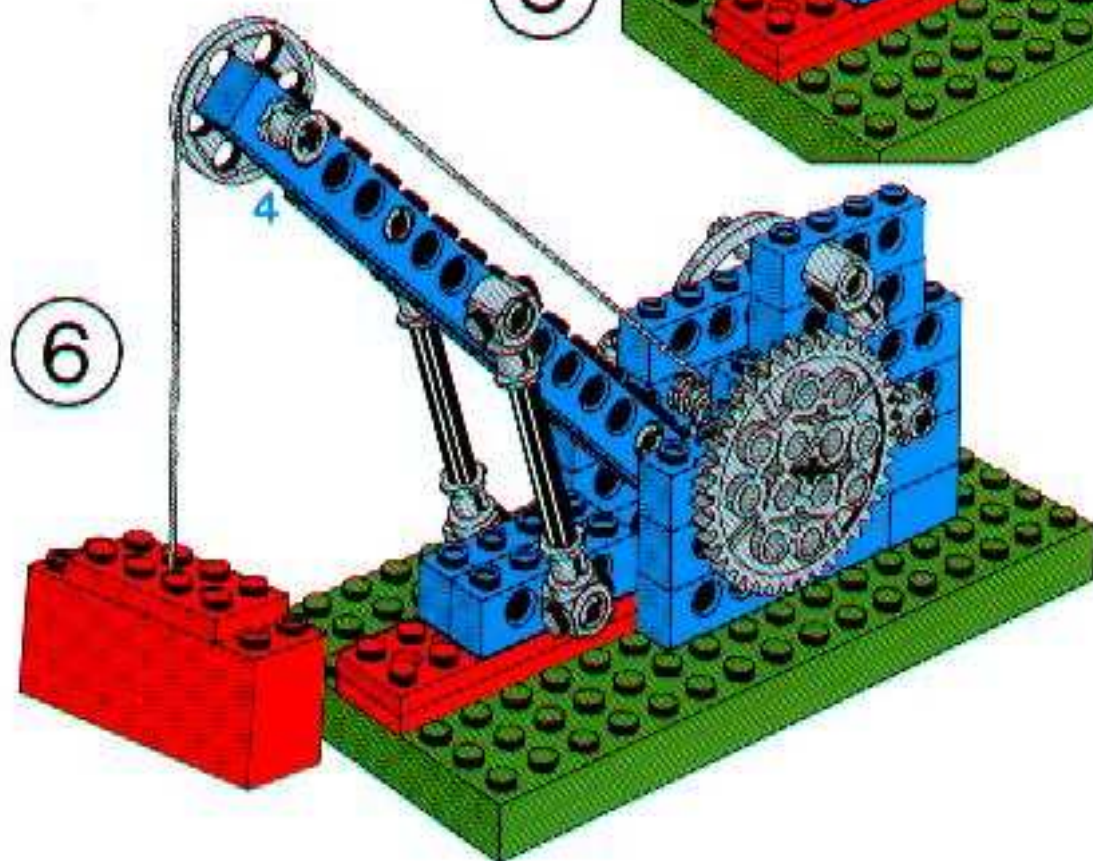
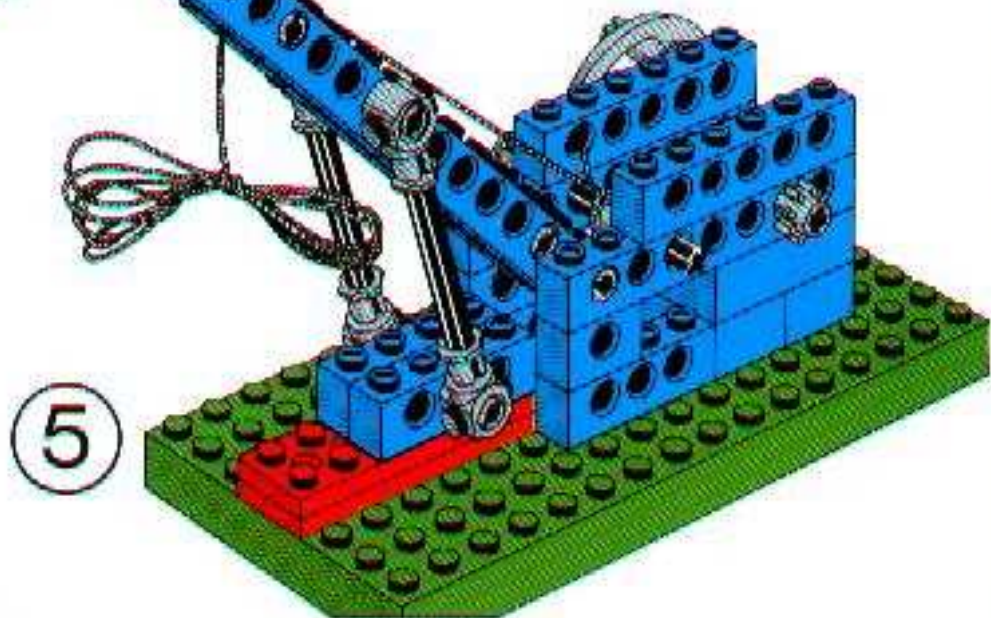
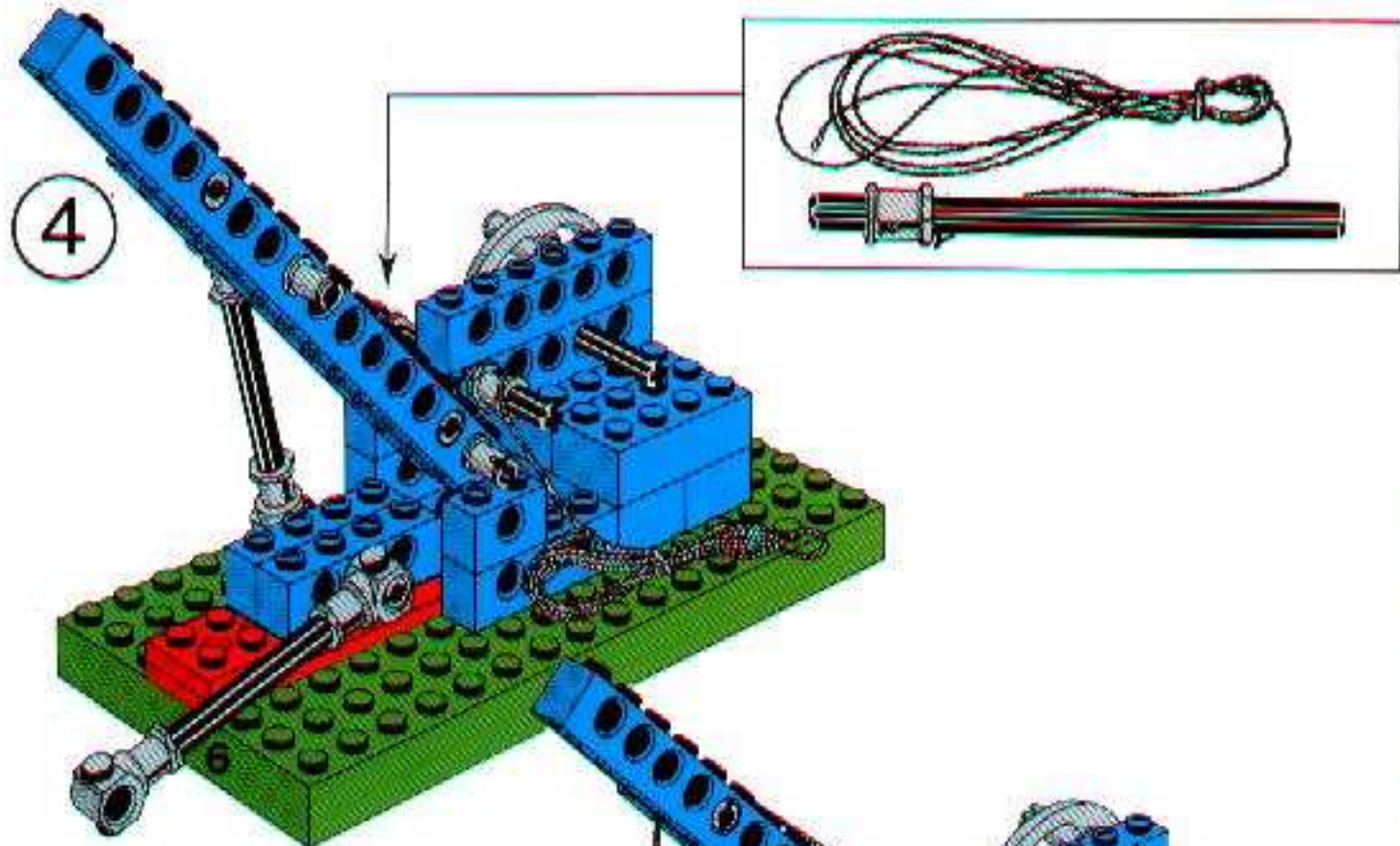

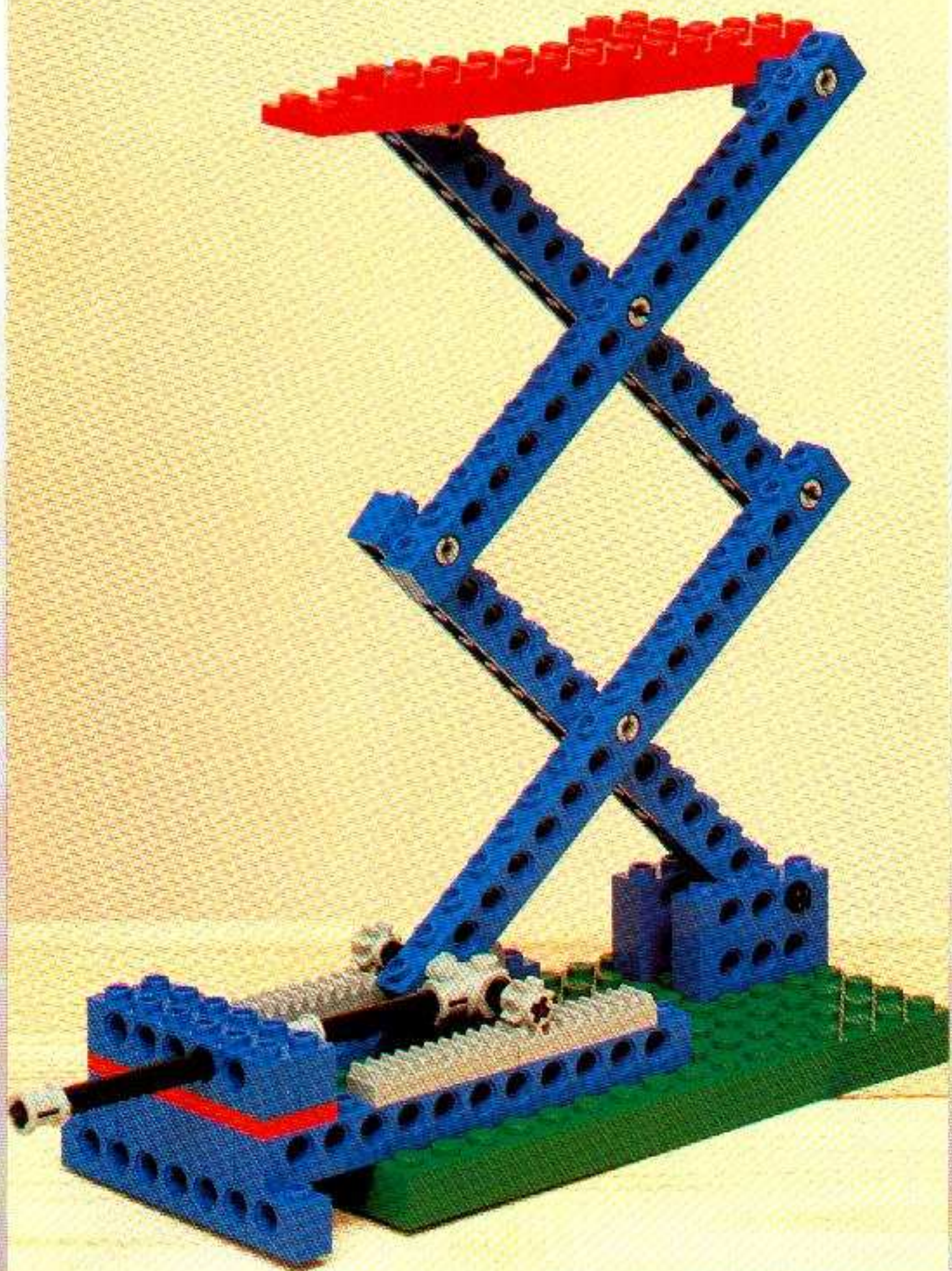



1031

16

1



2



3

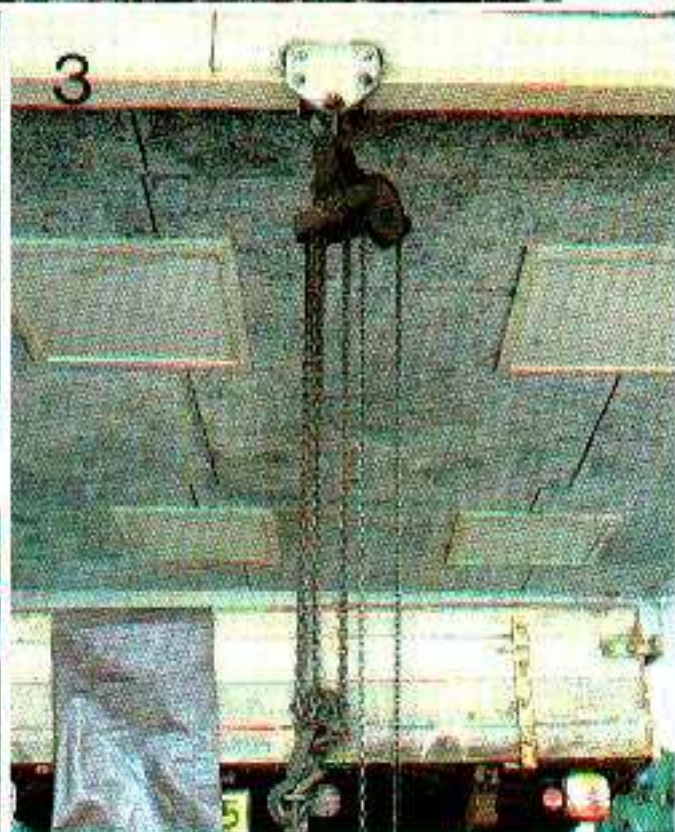

LEGO dacta

Technic

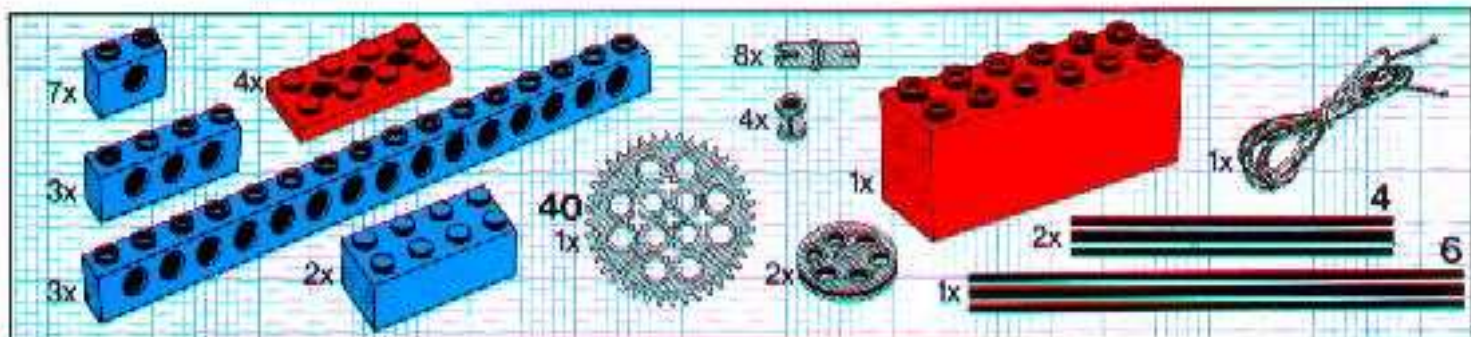

①

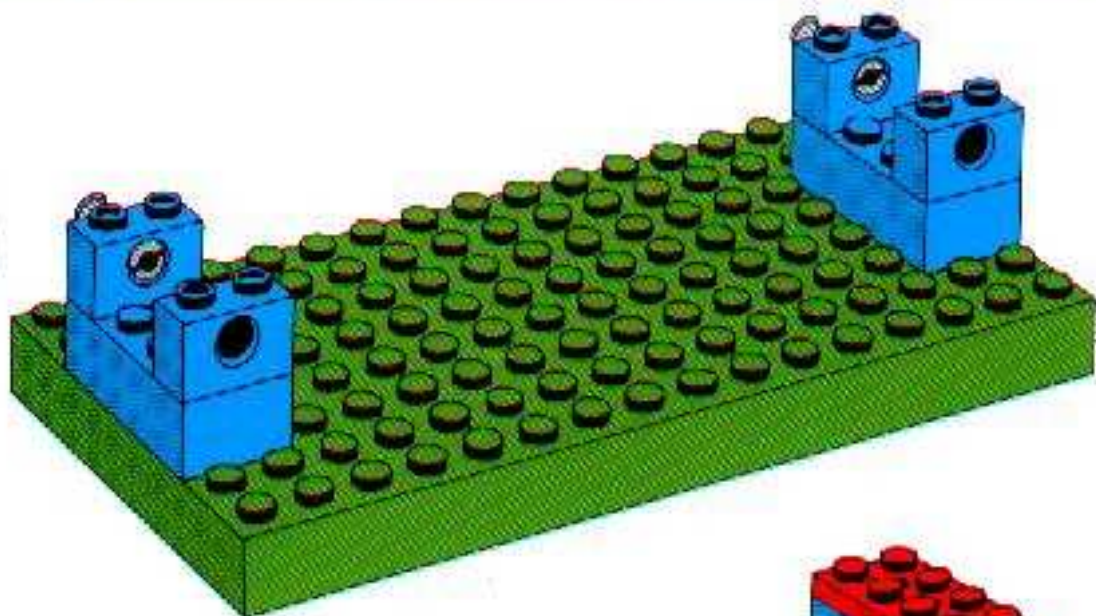

②

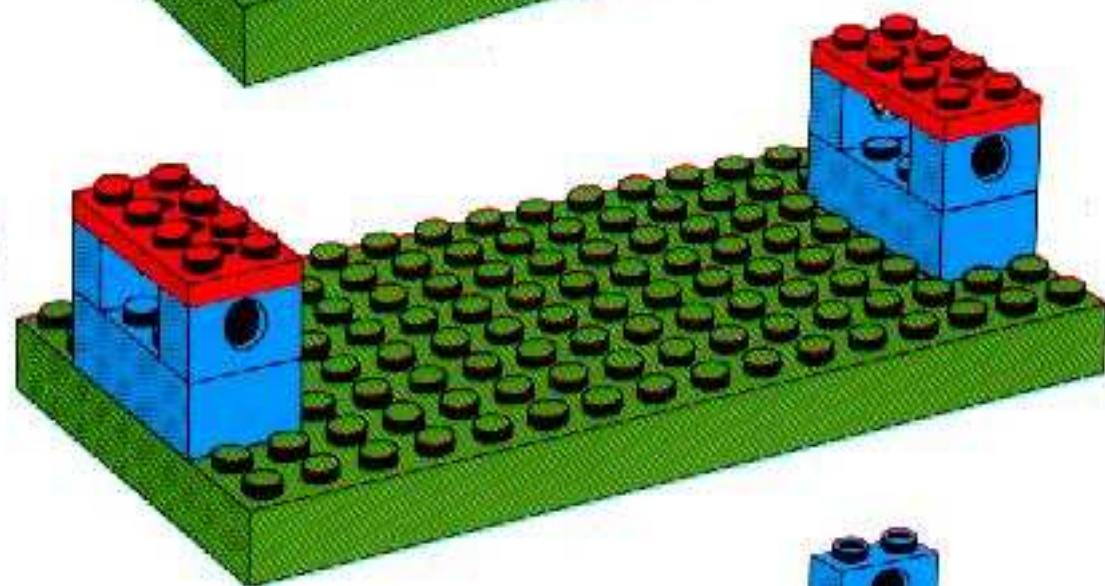

③

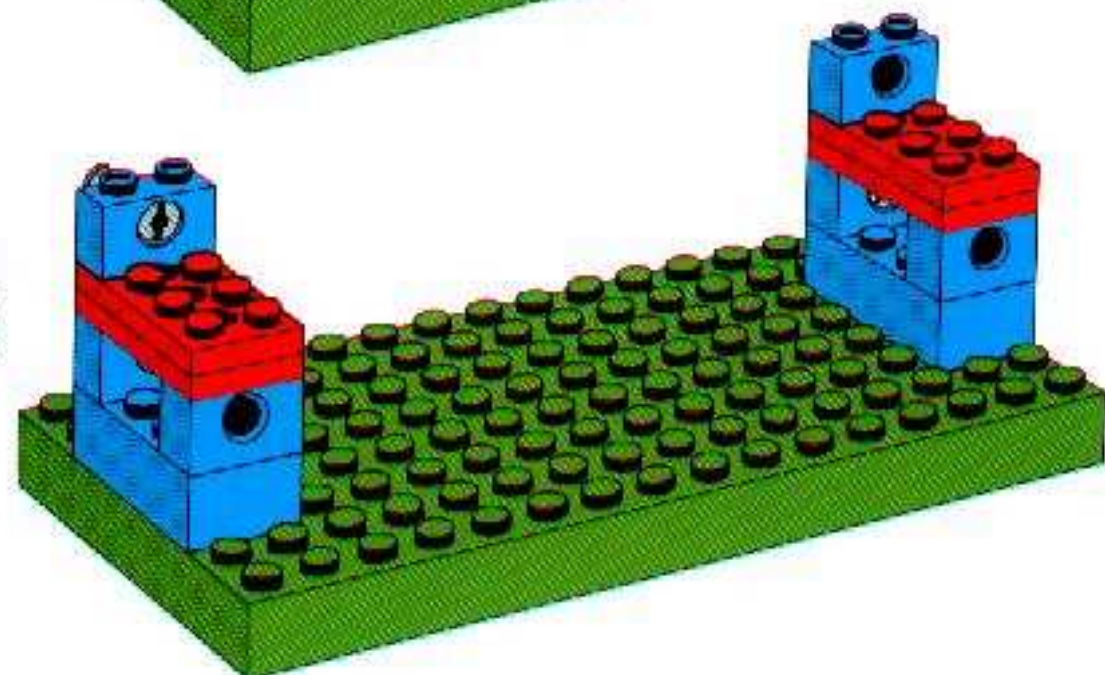

4

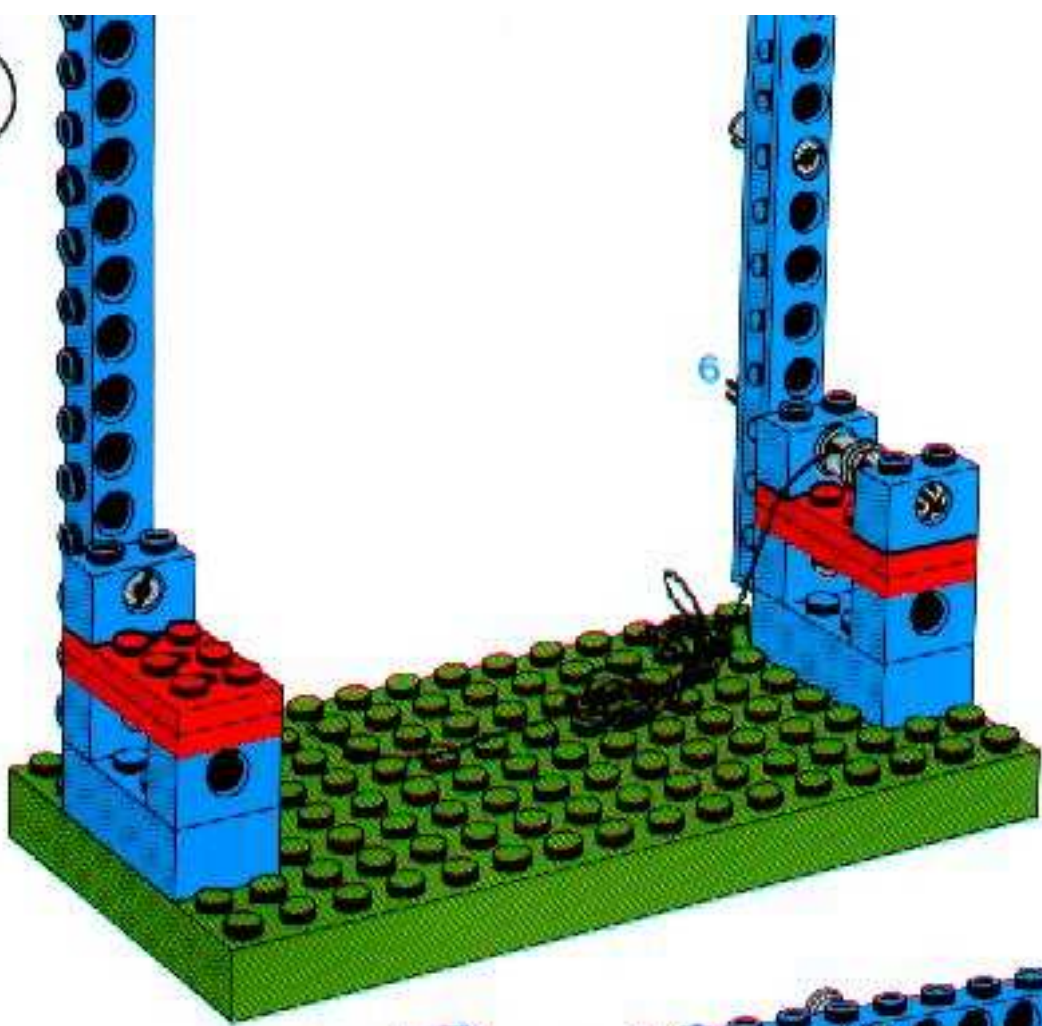

5

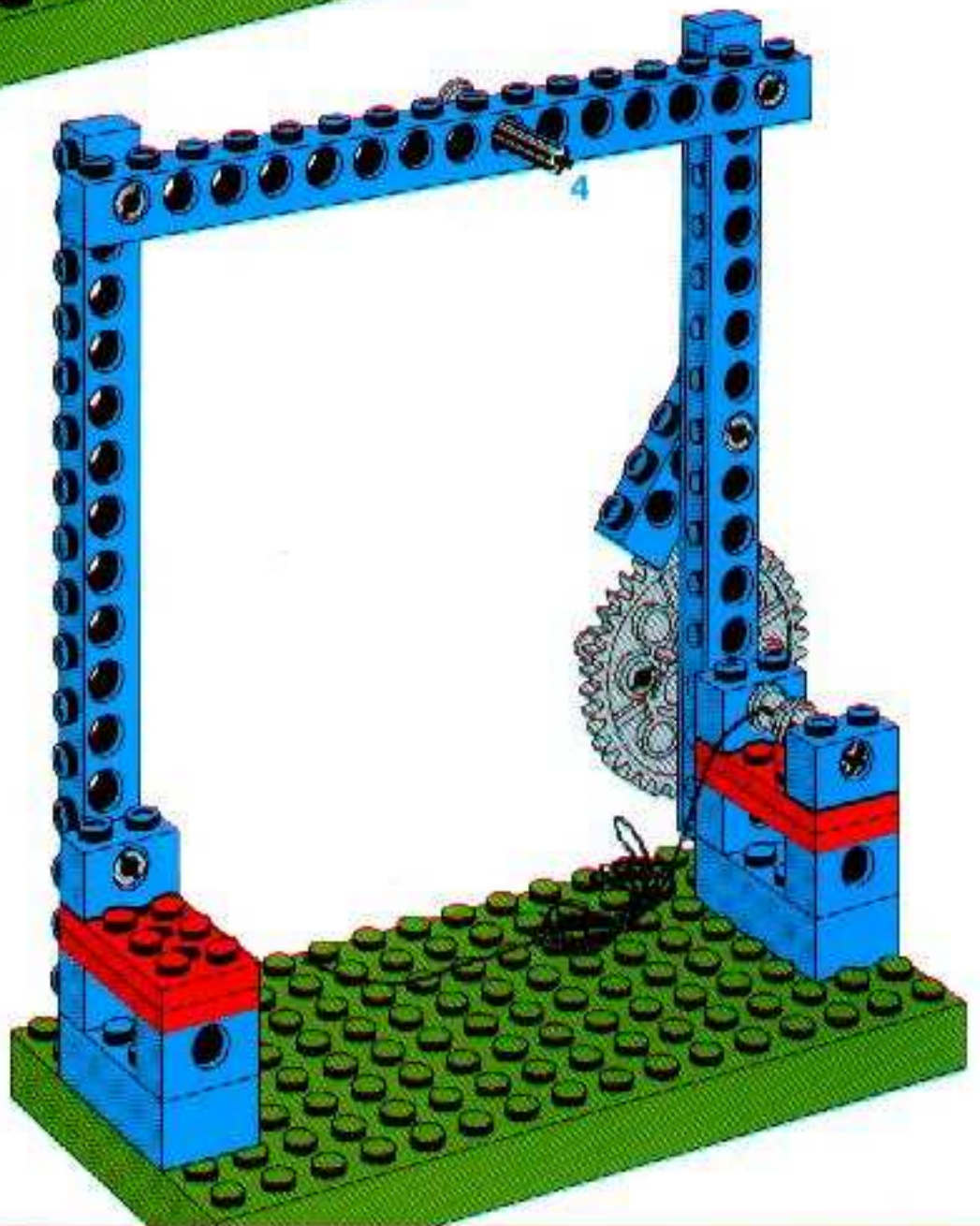

6

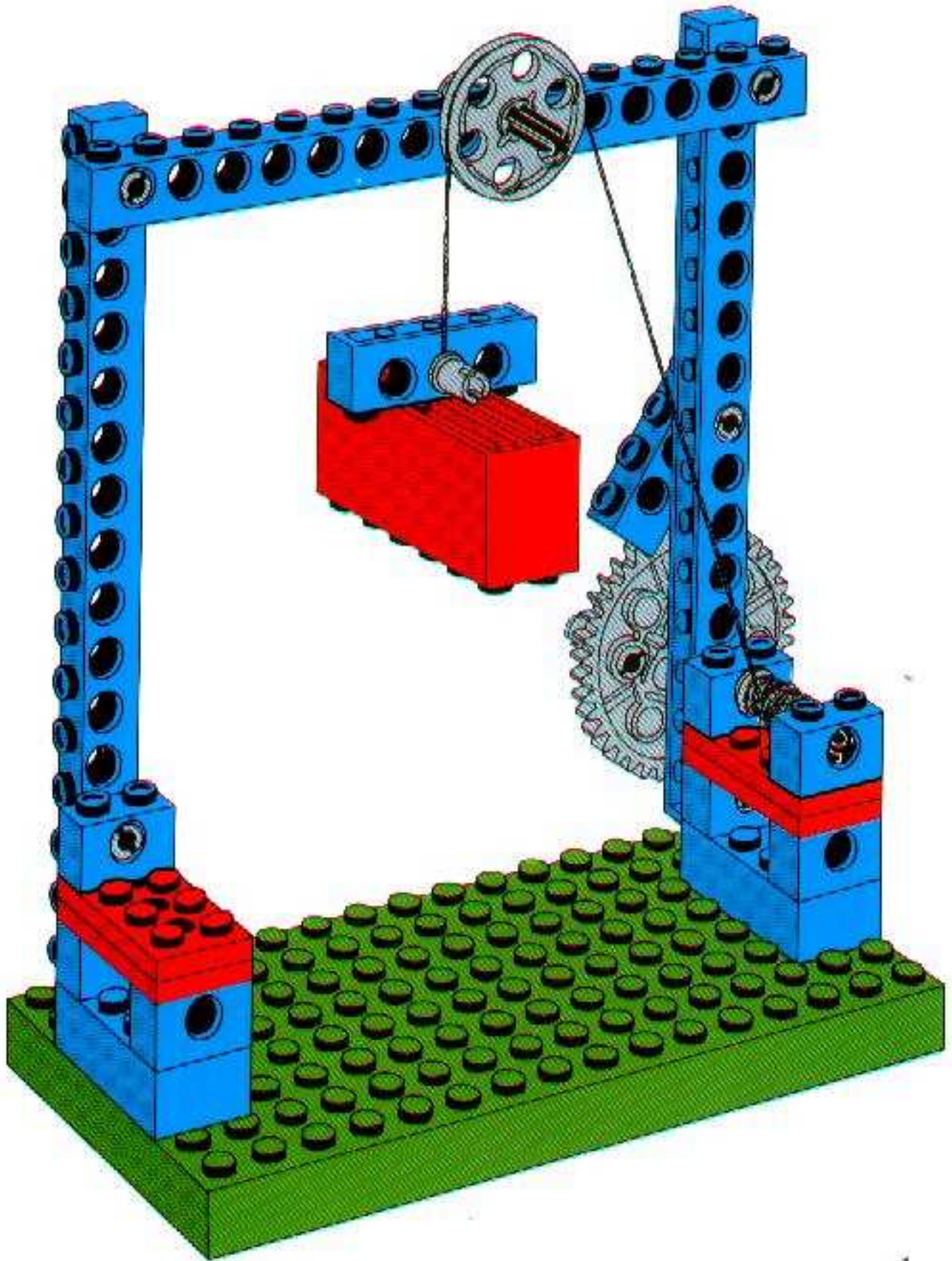

1

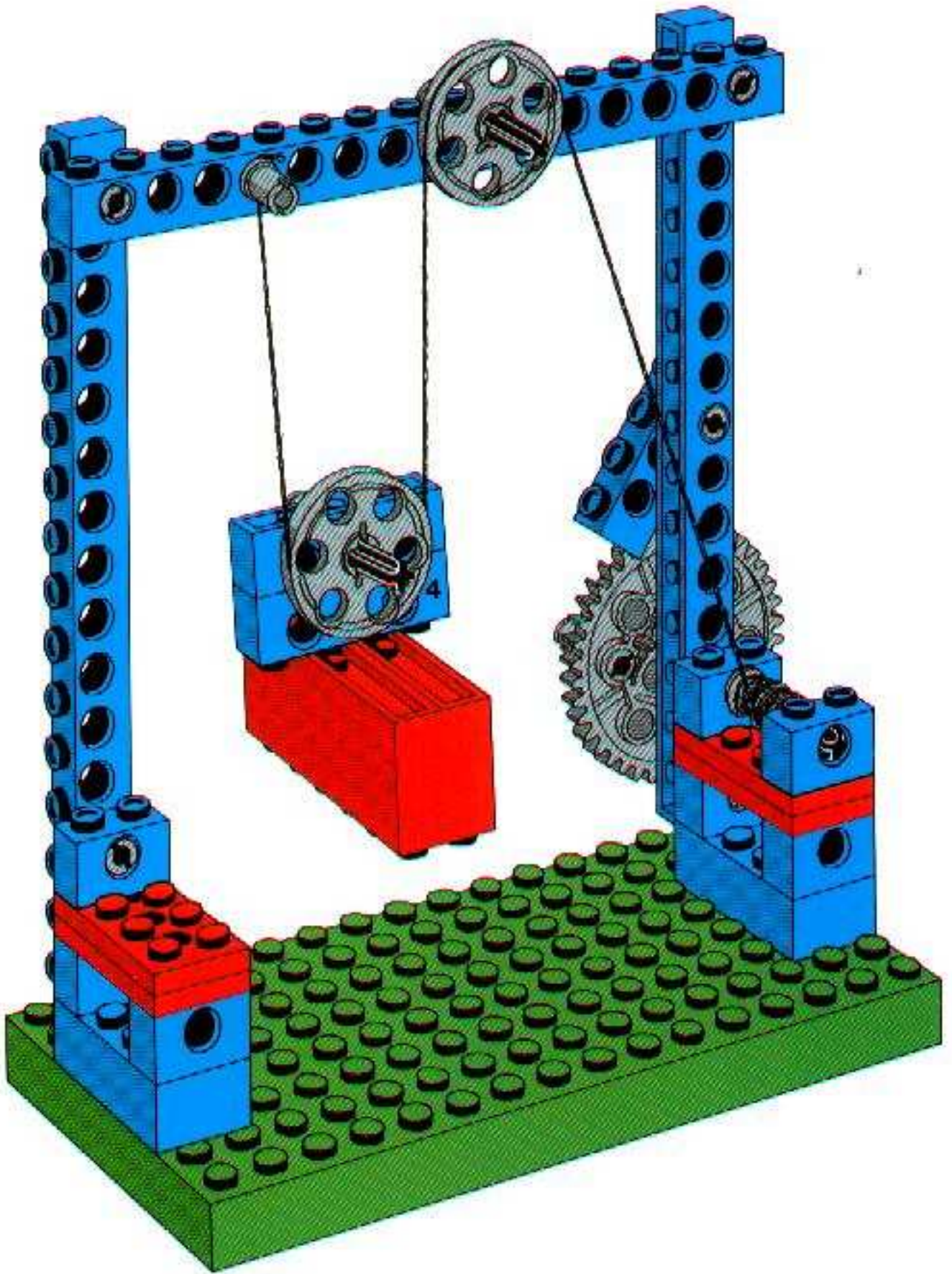

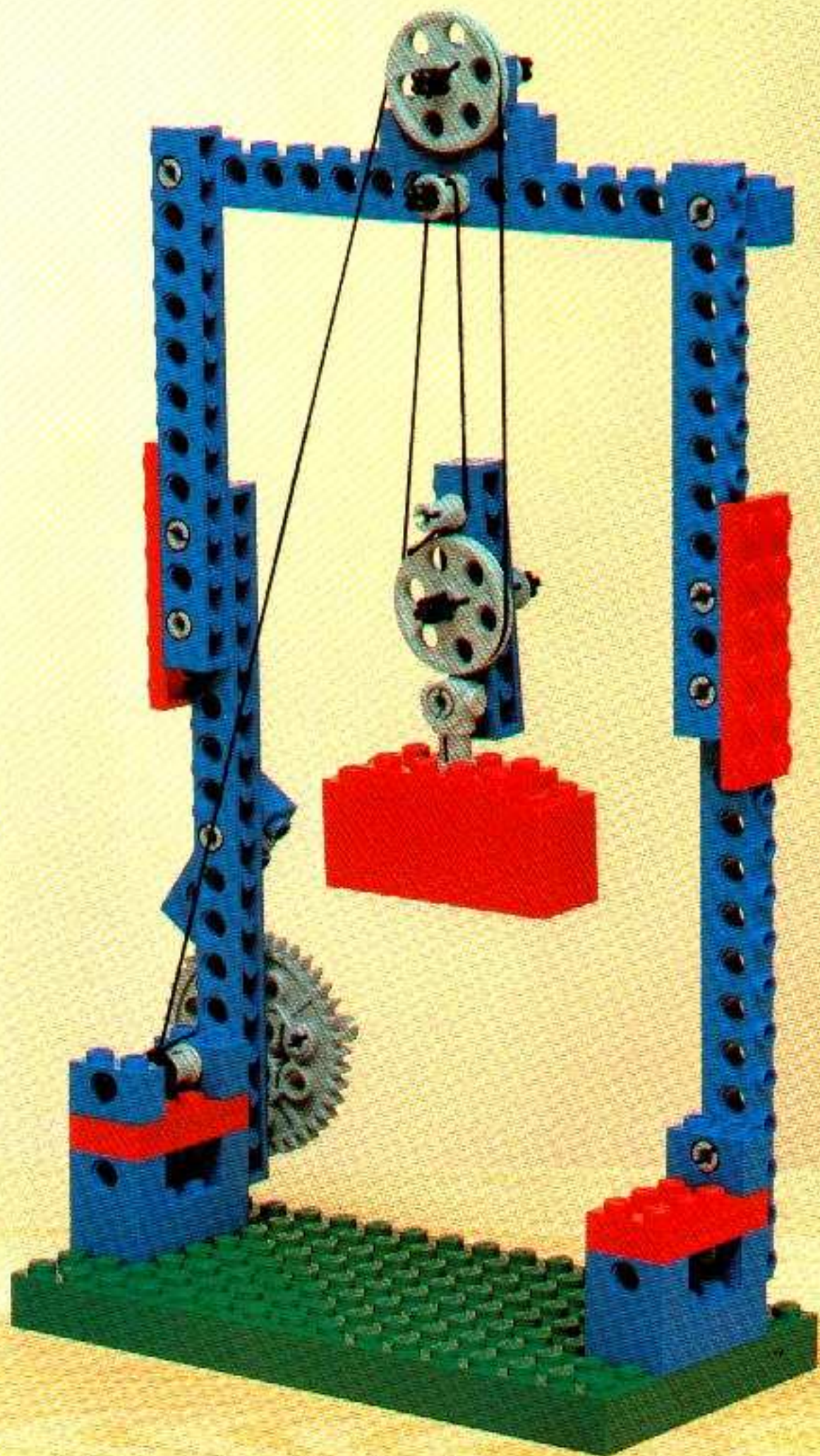



1031

17



2



LEGO dacta

Technic

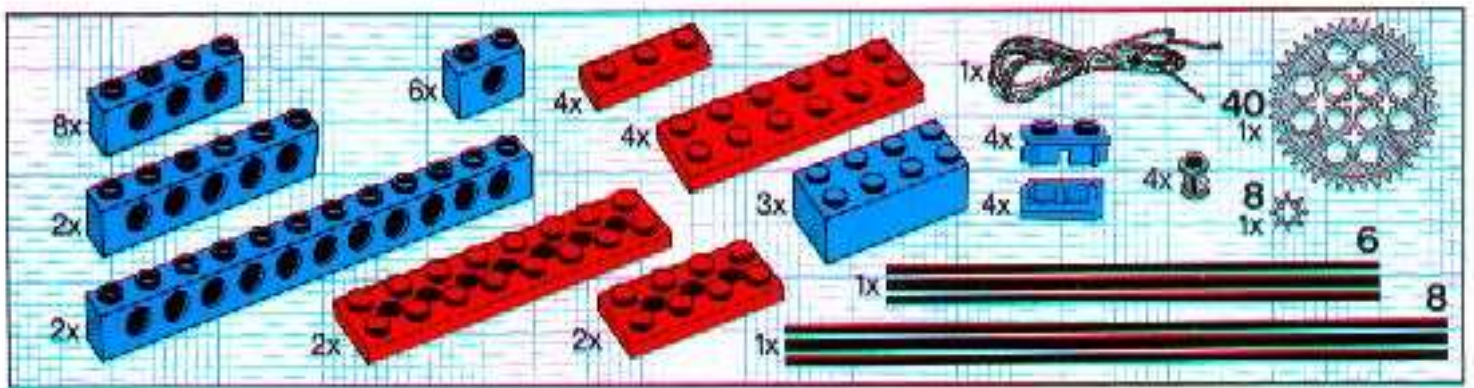

1

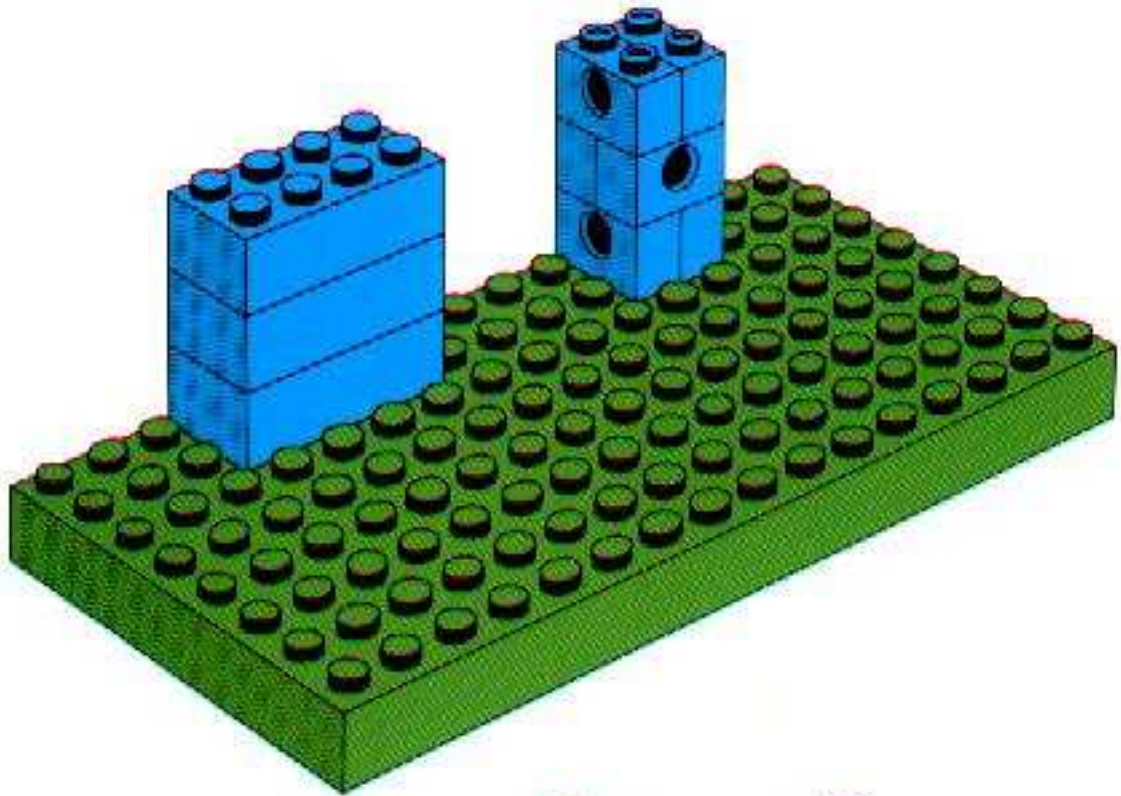

2

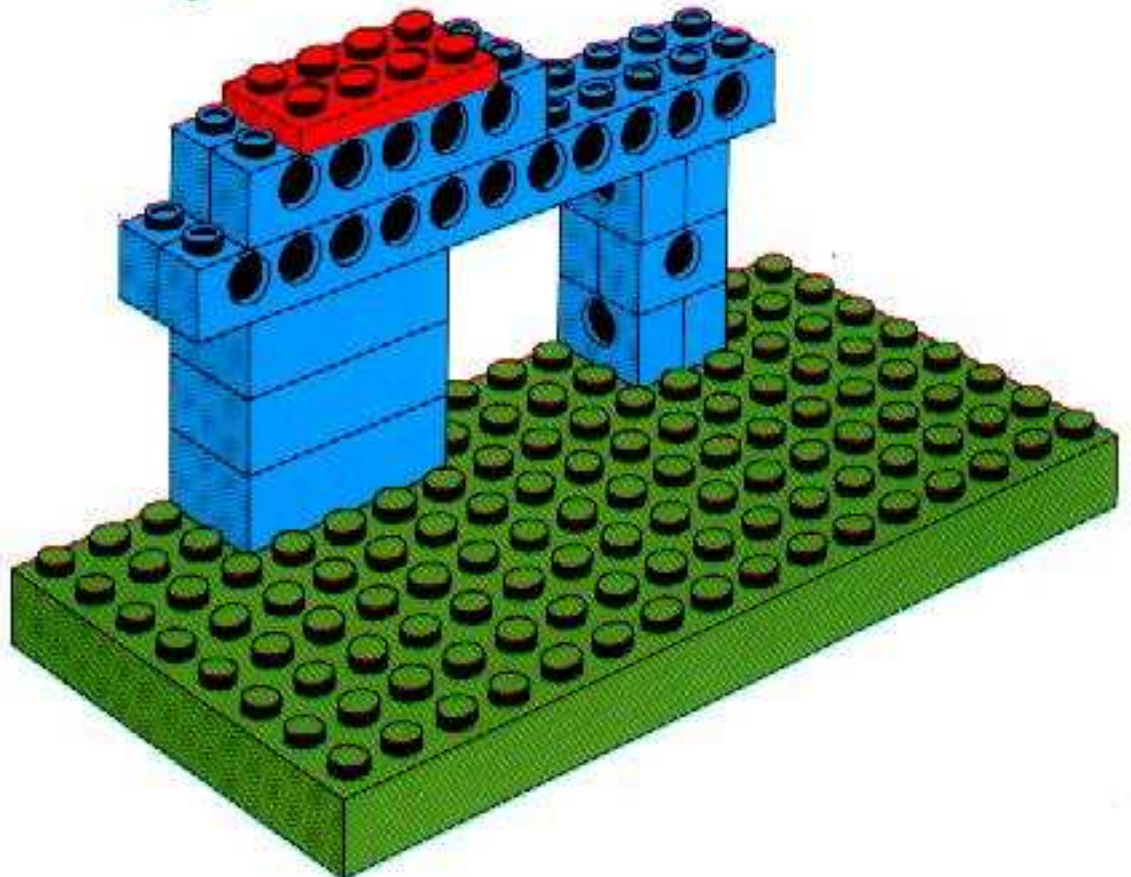

3

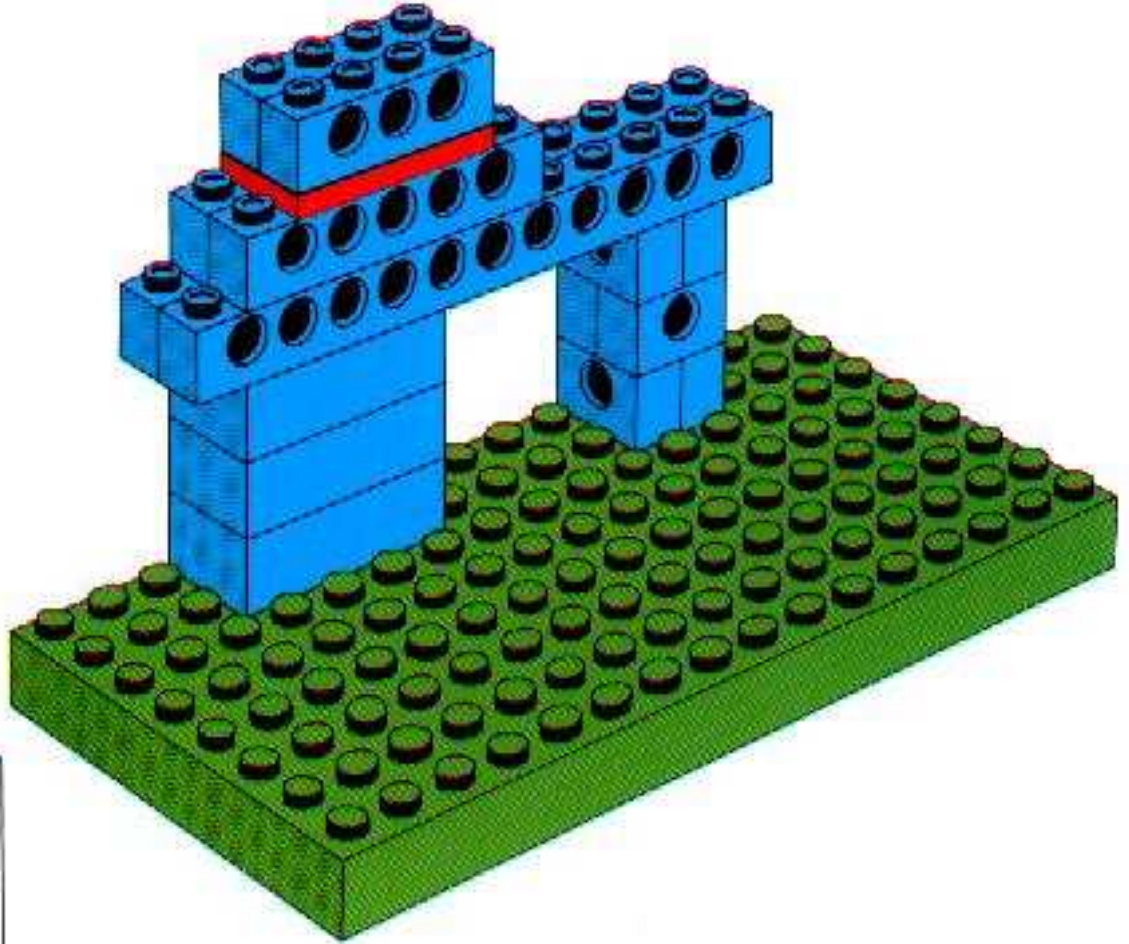

4

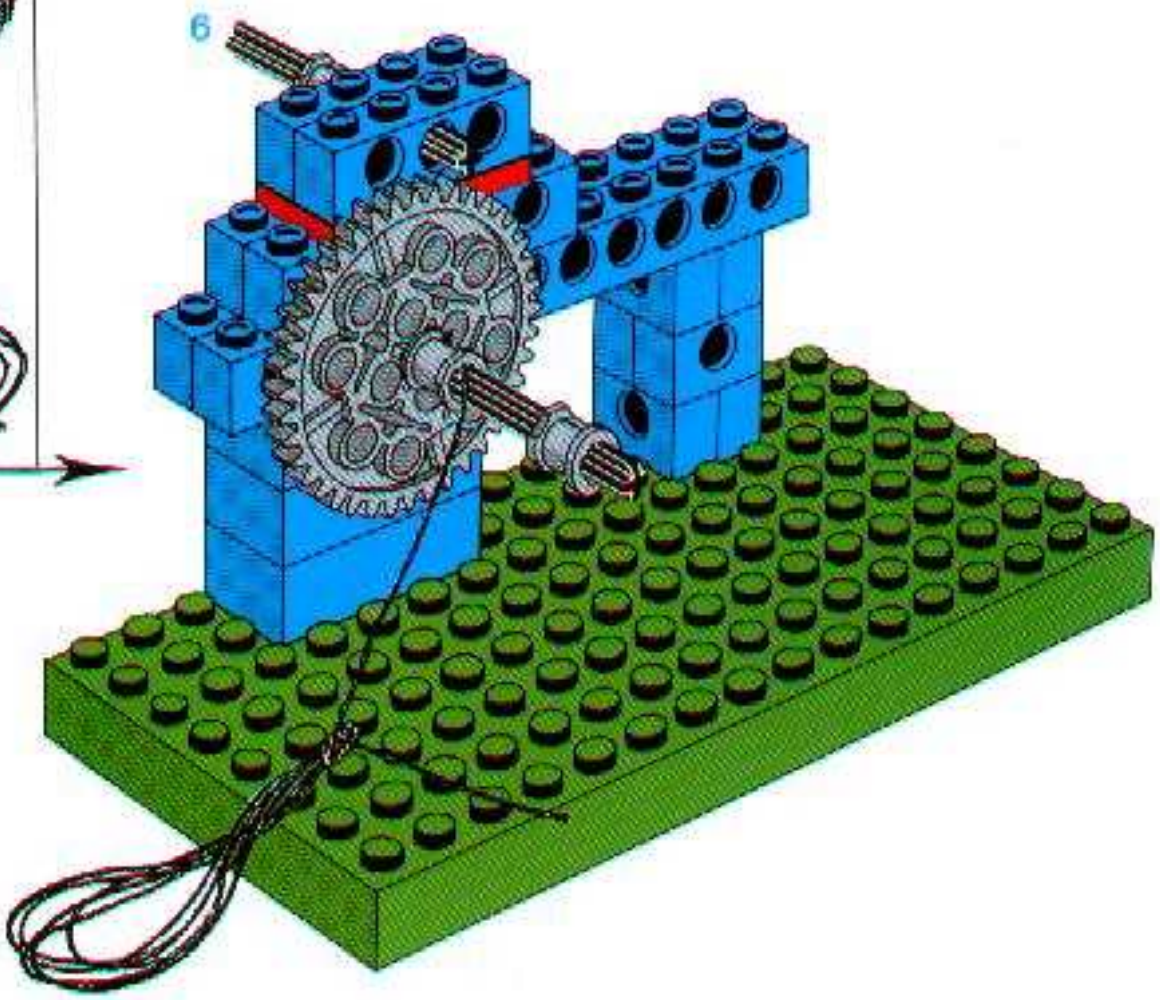

5

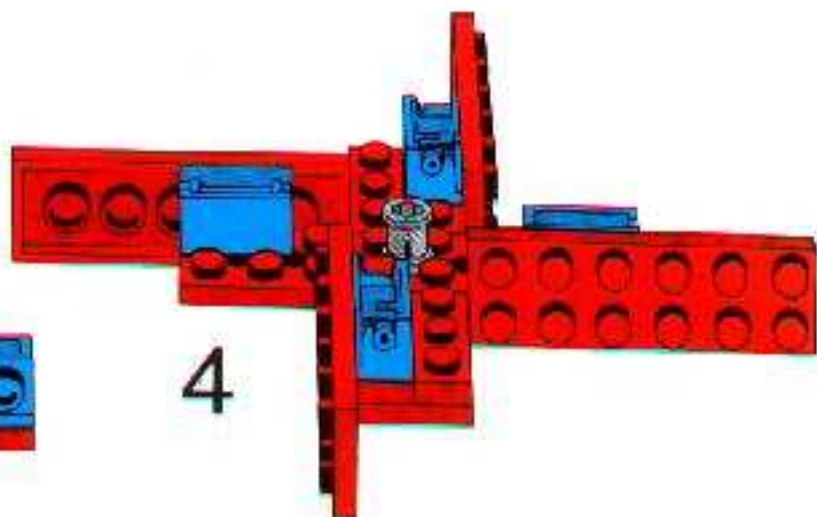
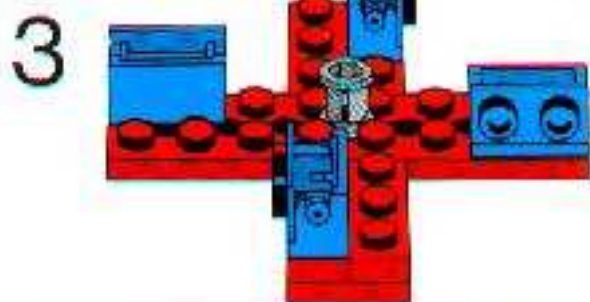
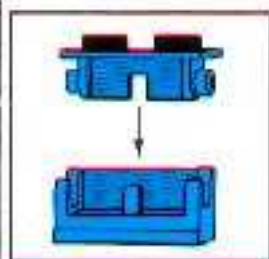
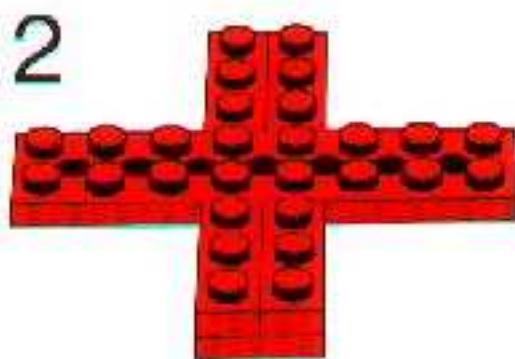
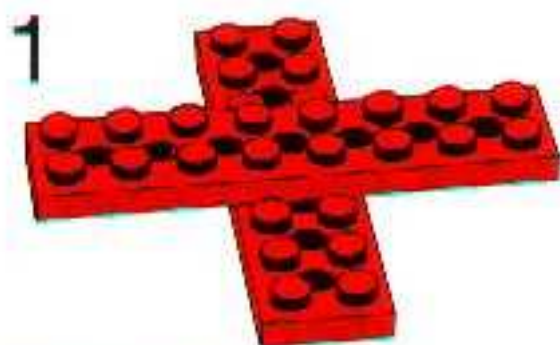
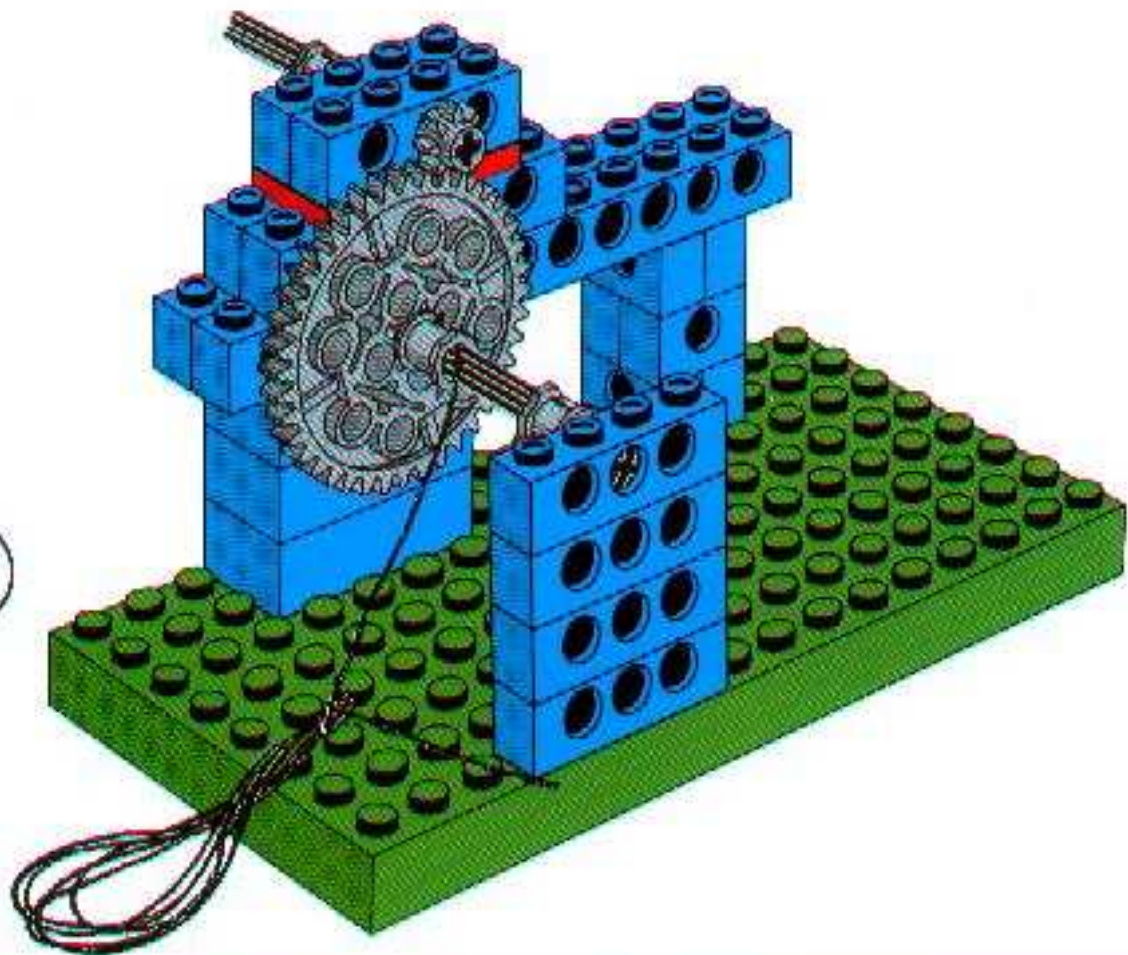

6

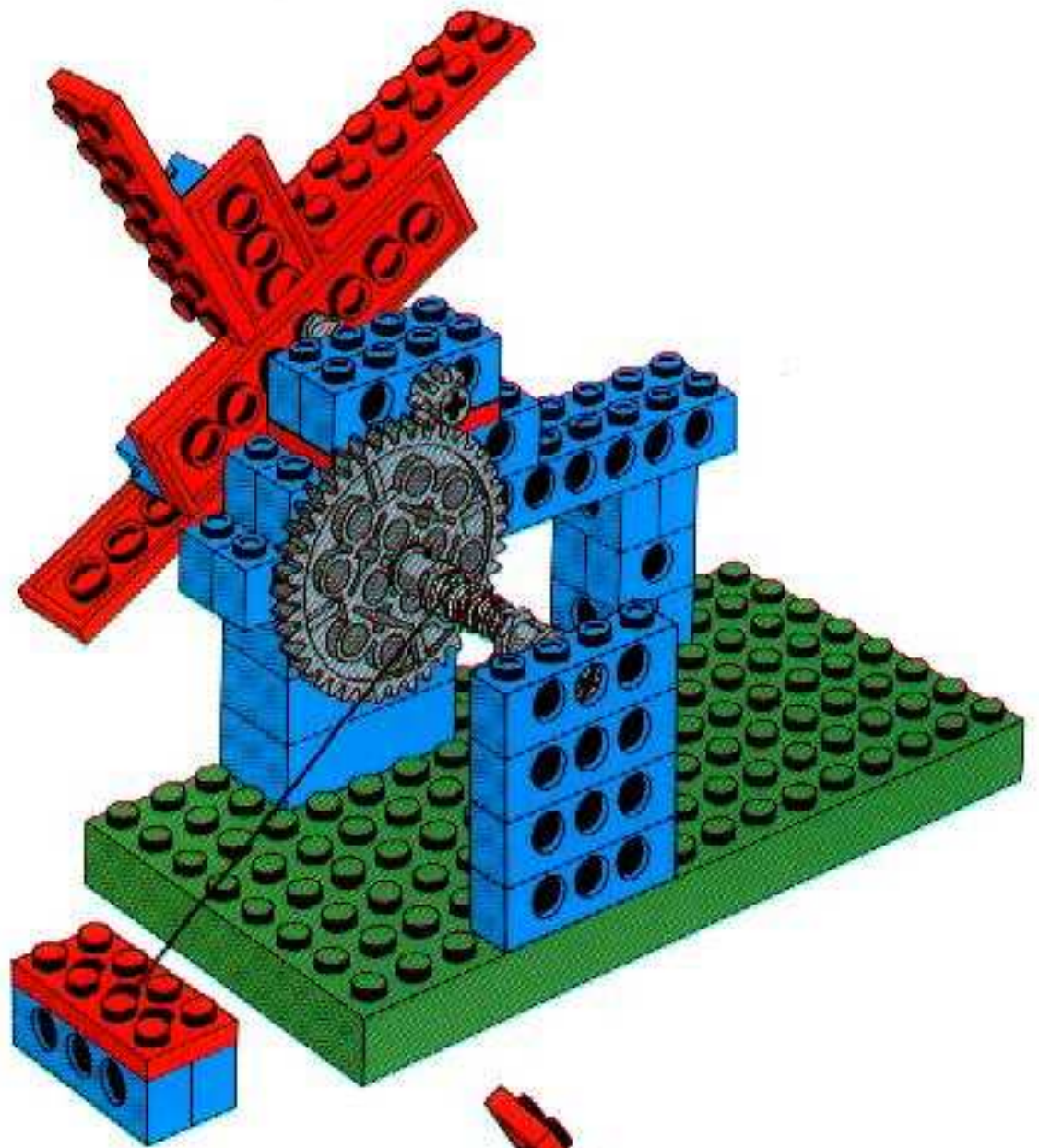

6

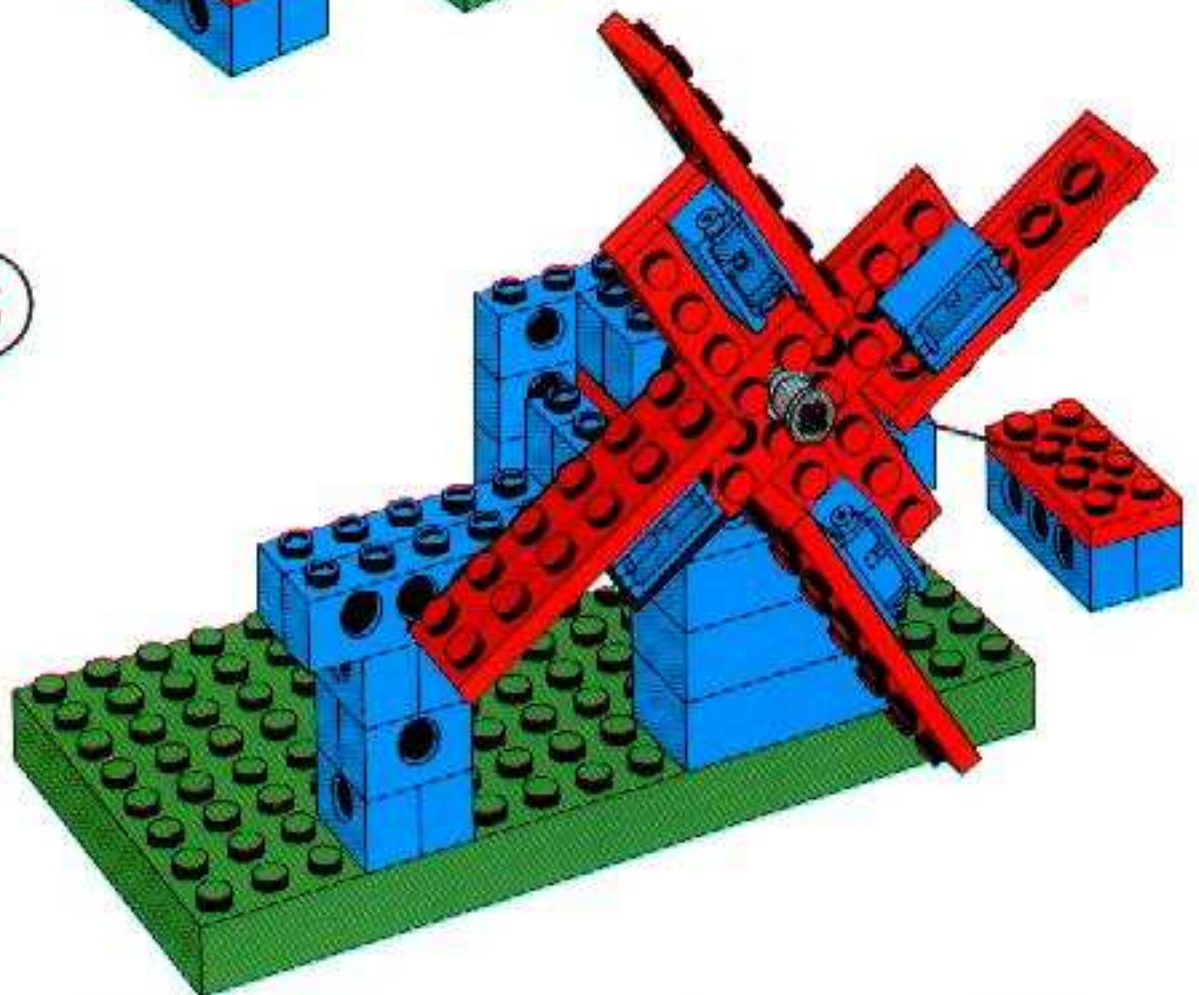

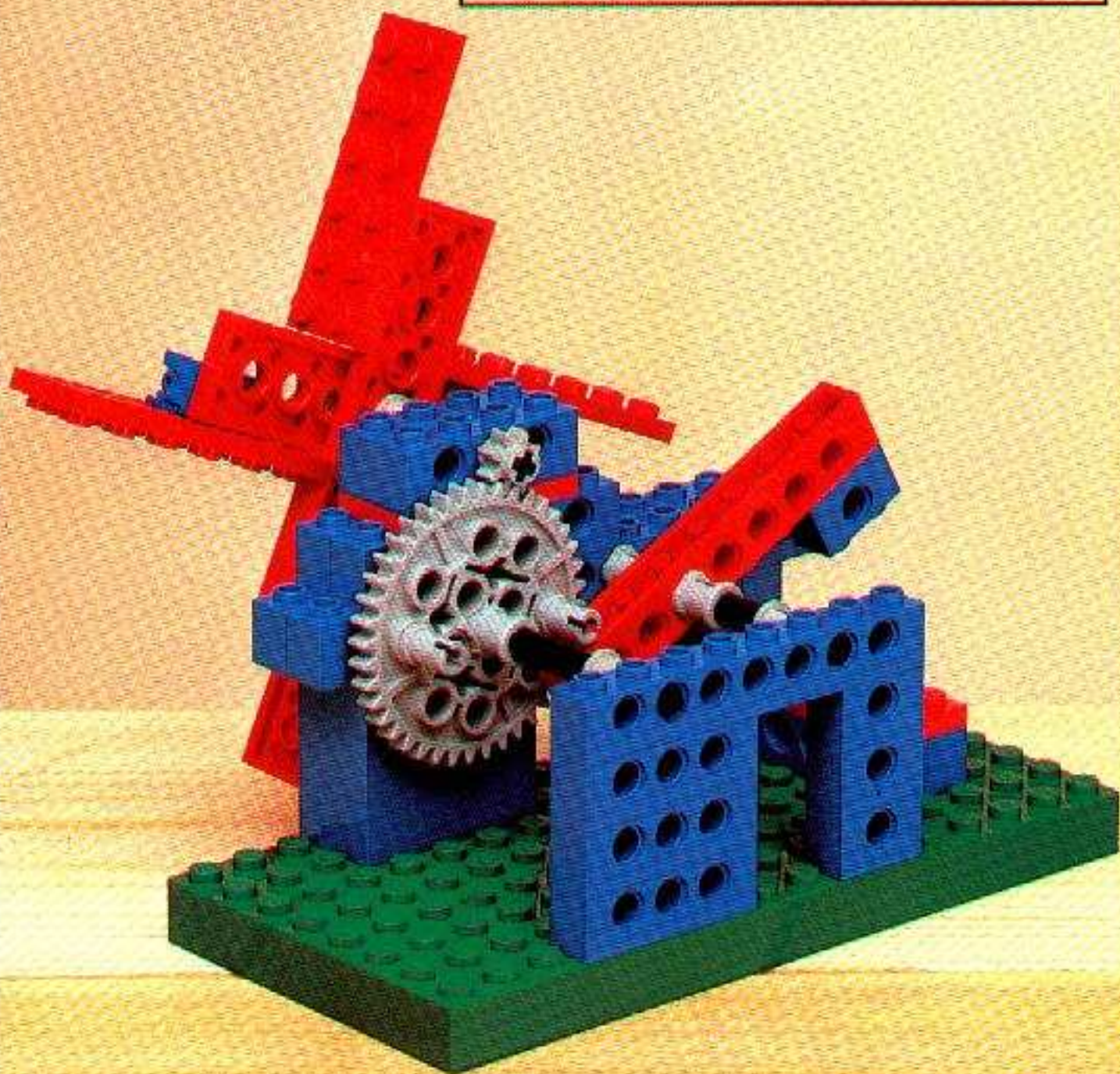
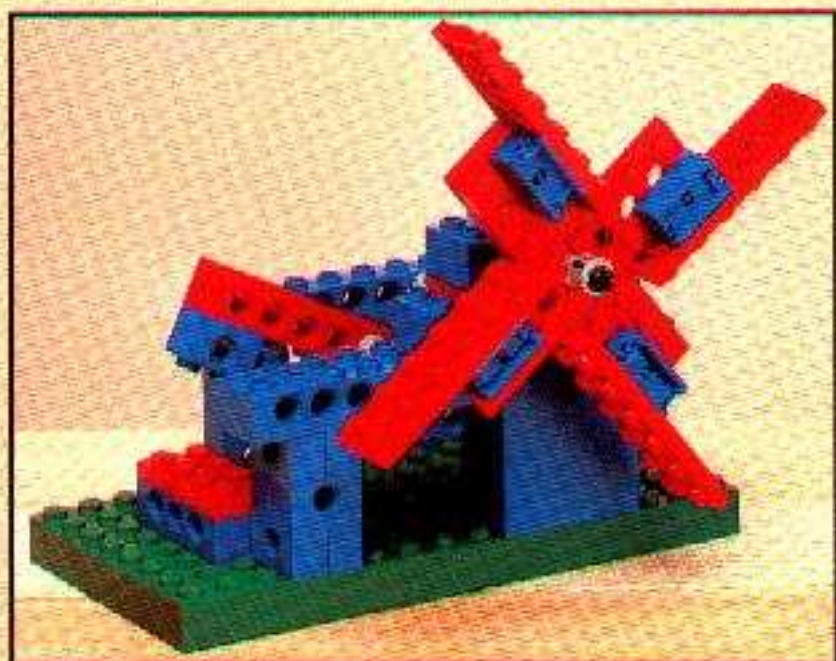



1031

18



2



3



4

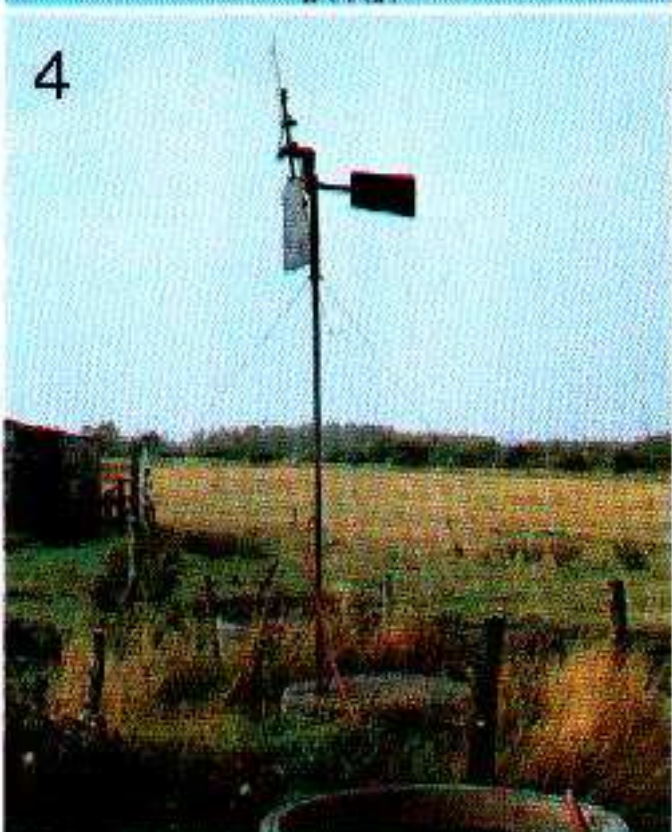

LEGO dacta

Technic

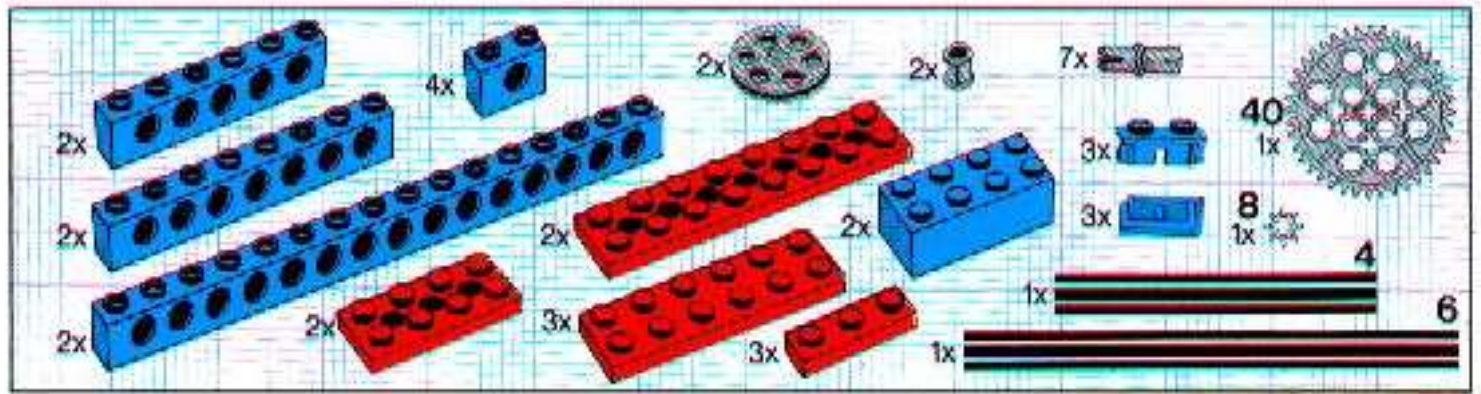

1

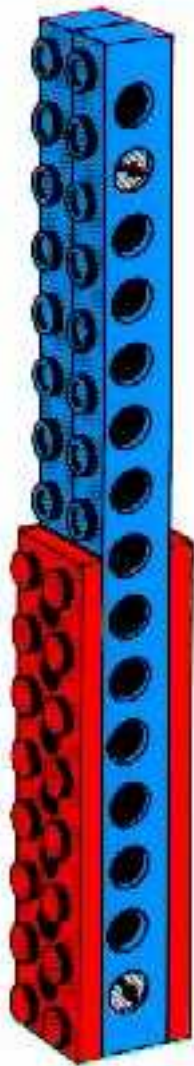

2

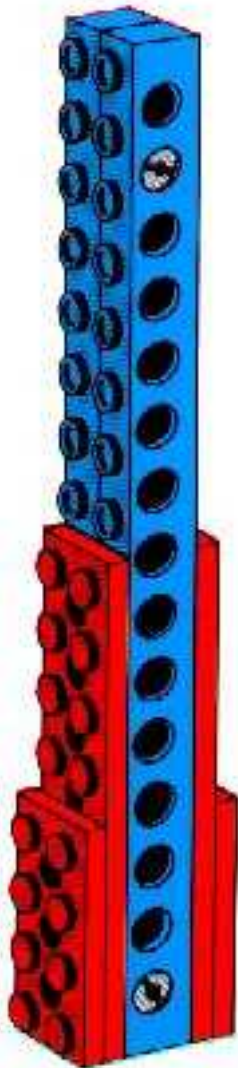

3

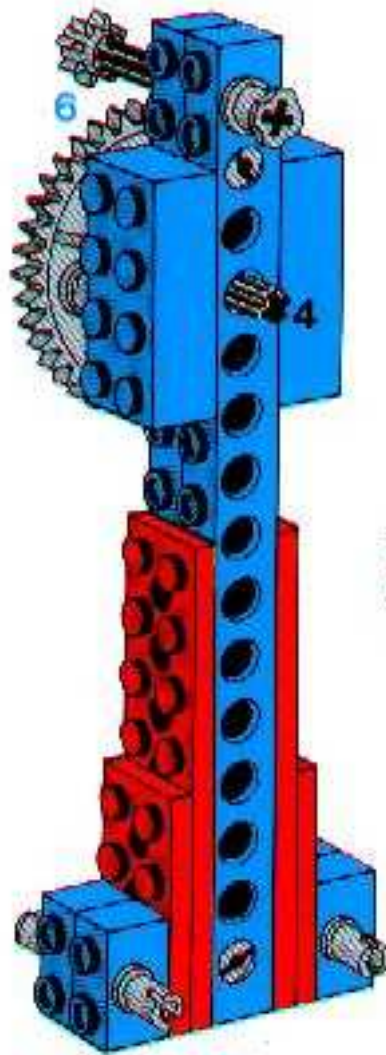

4

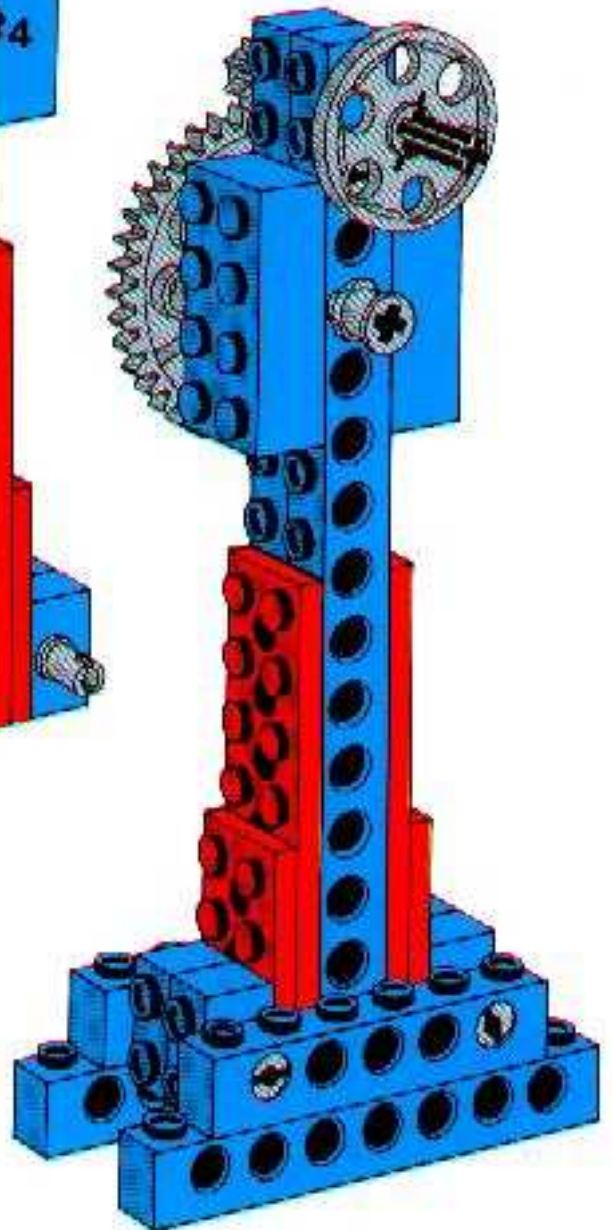

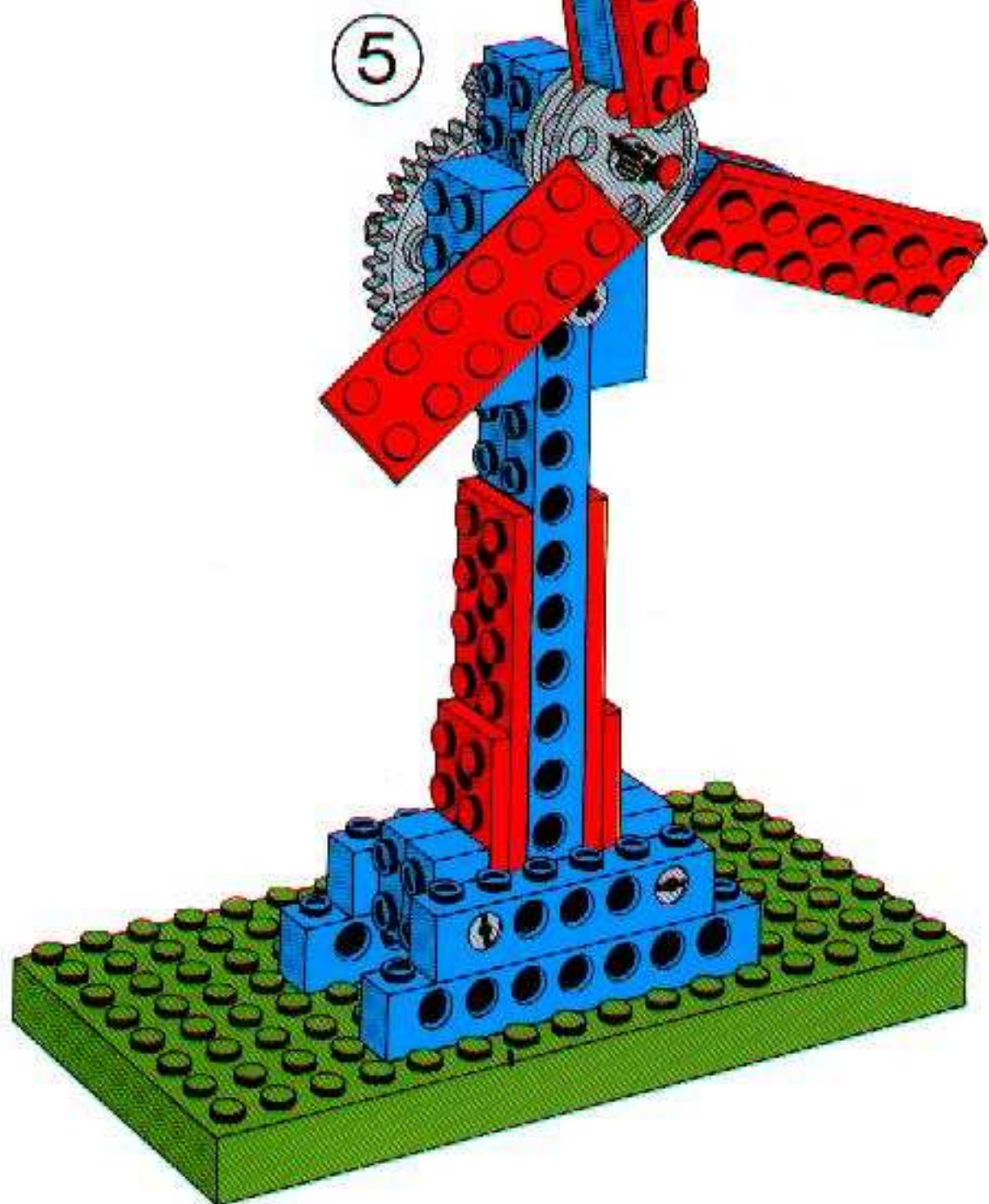
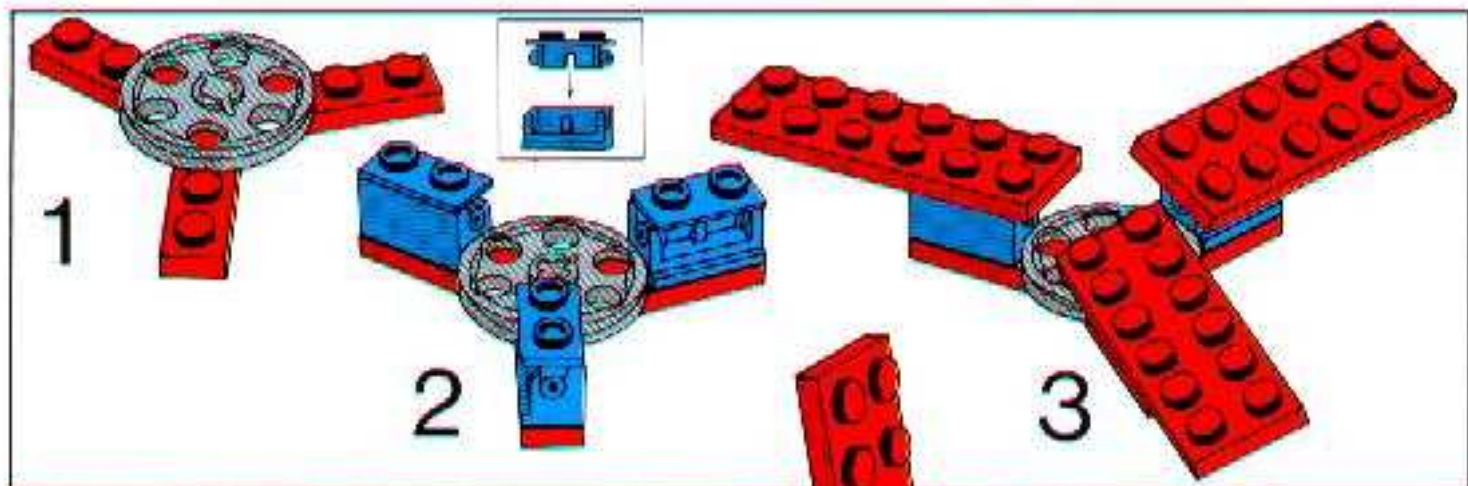

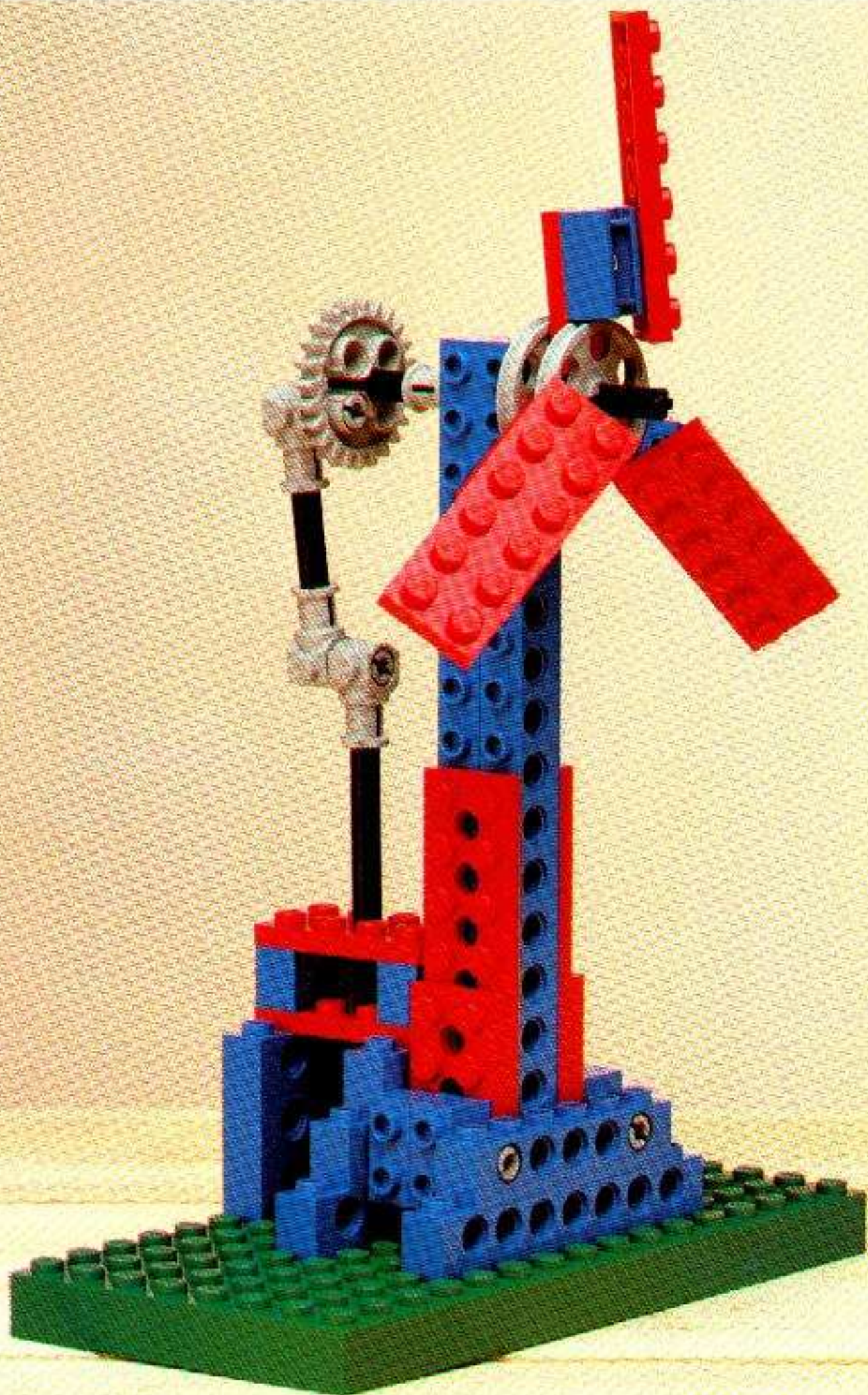



1031

19

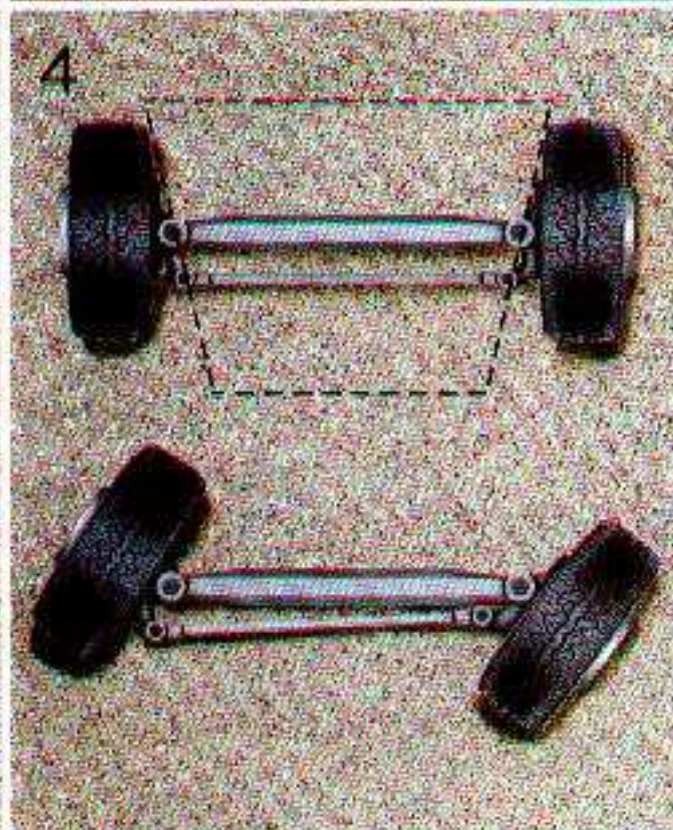
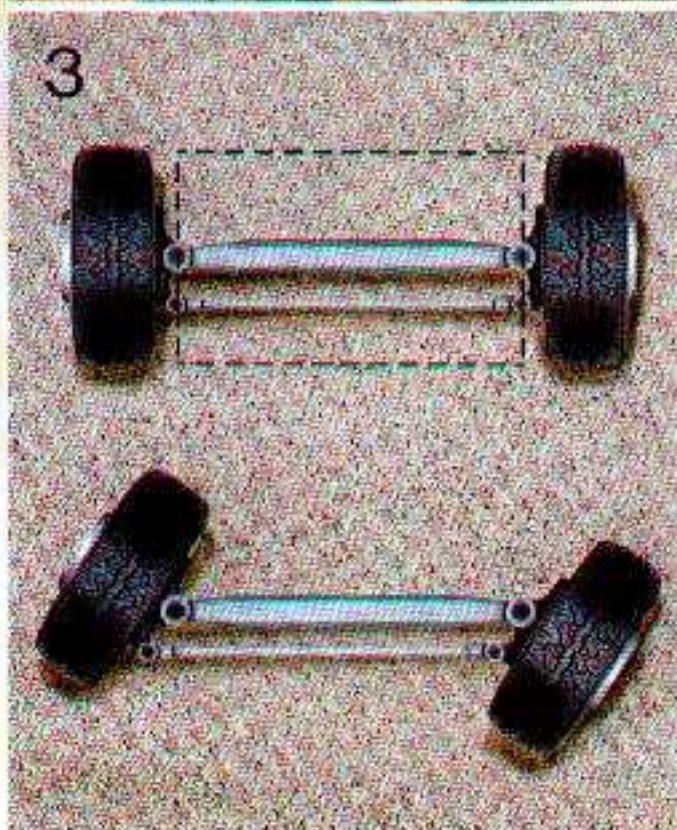

LEGO dacta

Technic

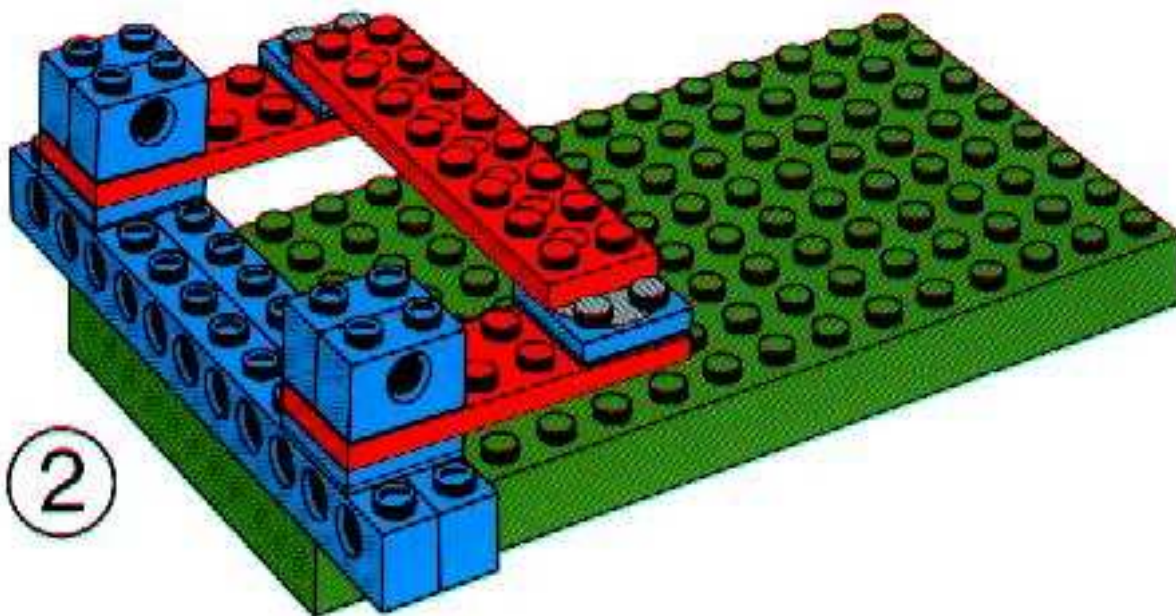
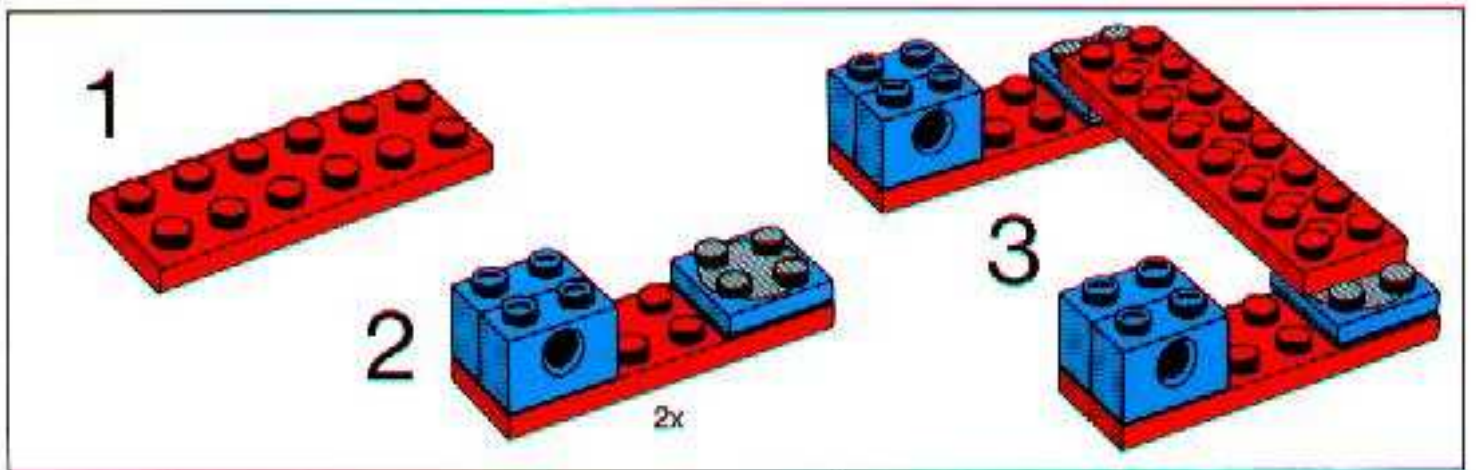
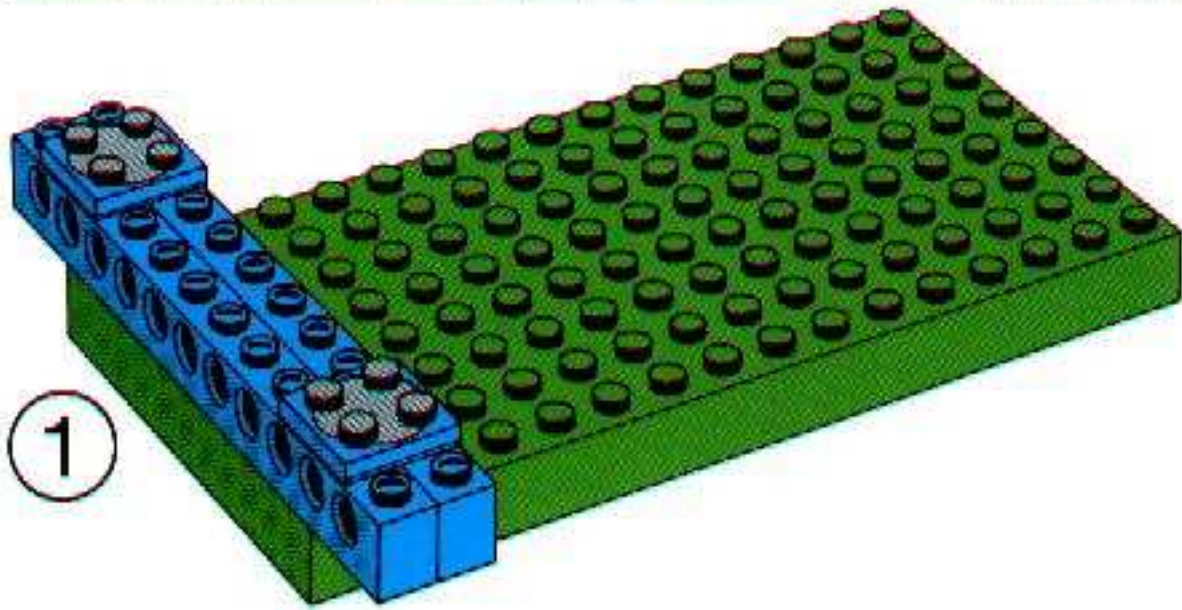
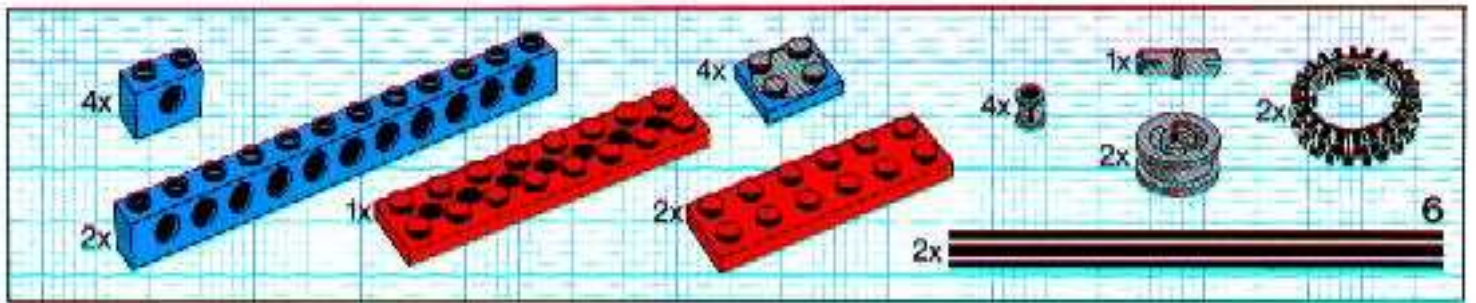

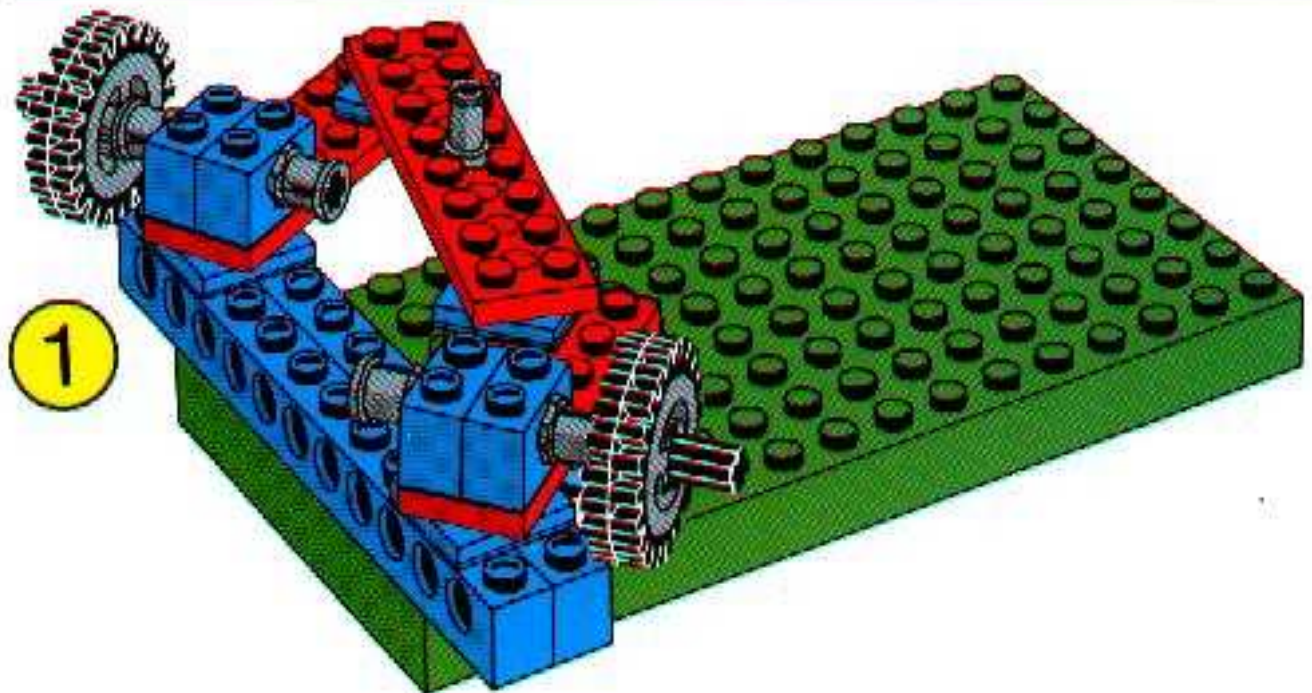
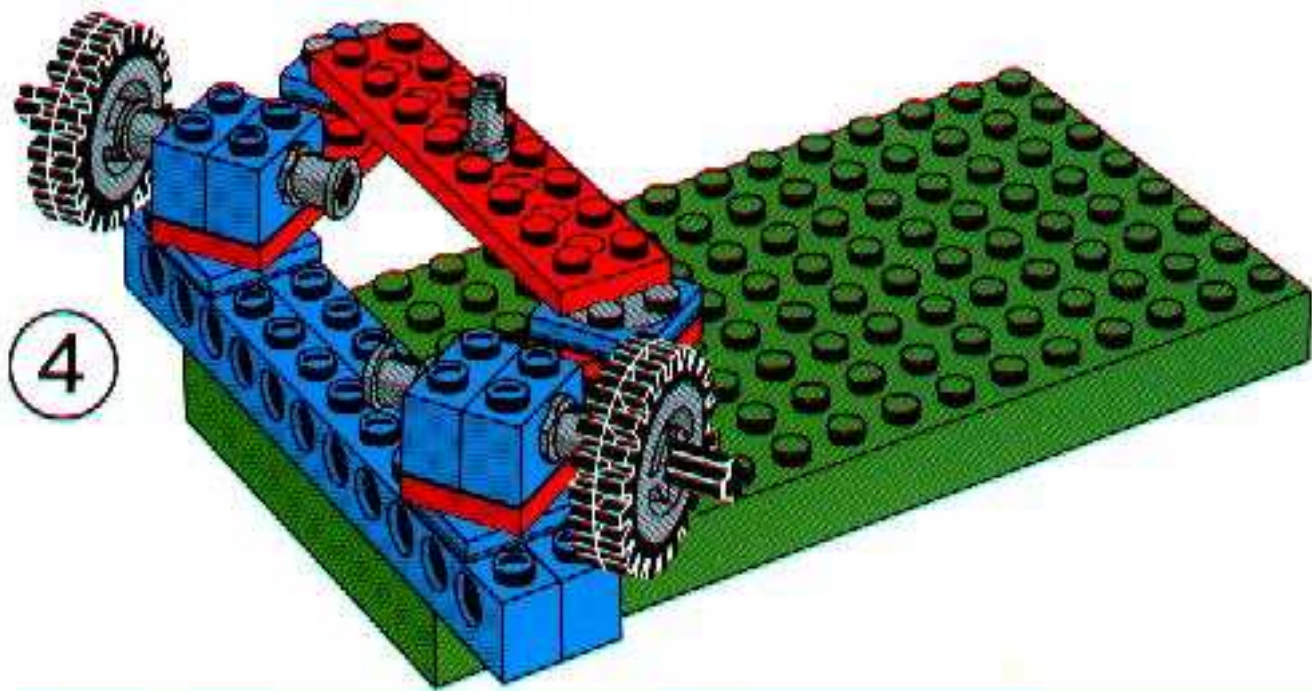
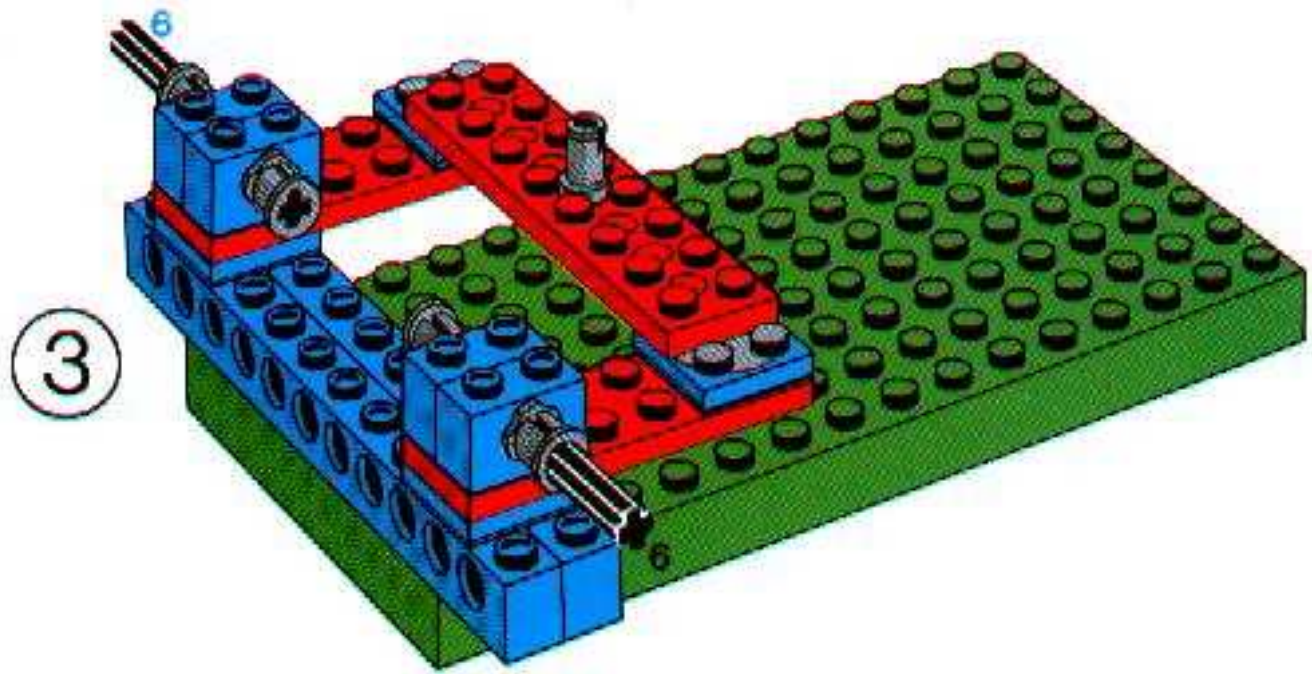

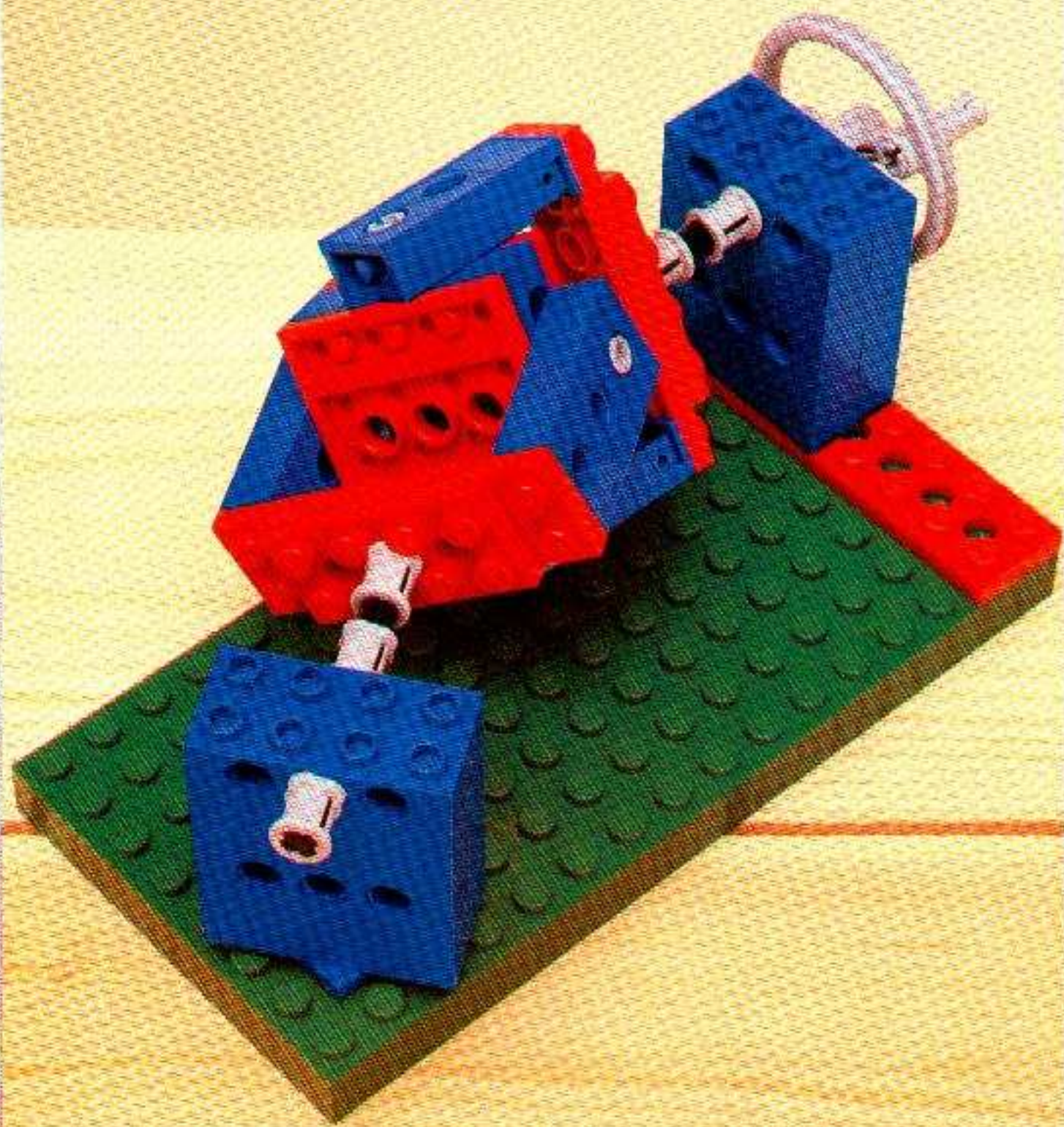

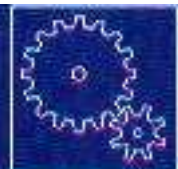

1031 20



2

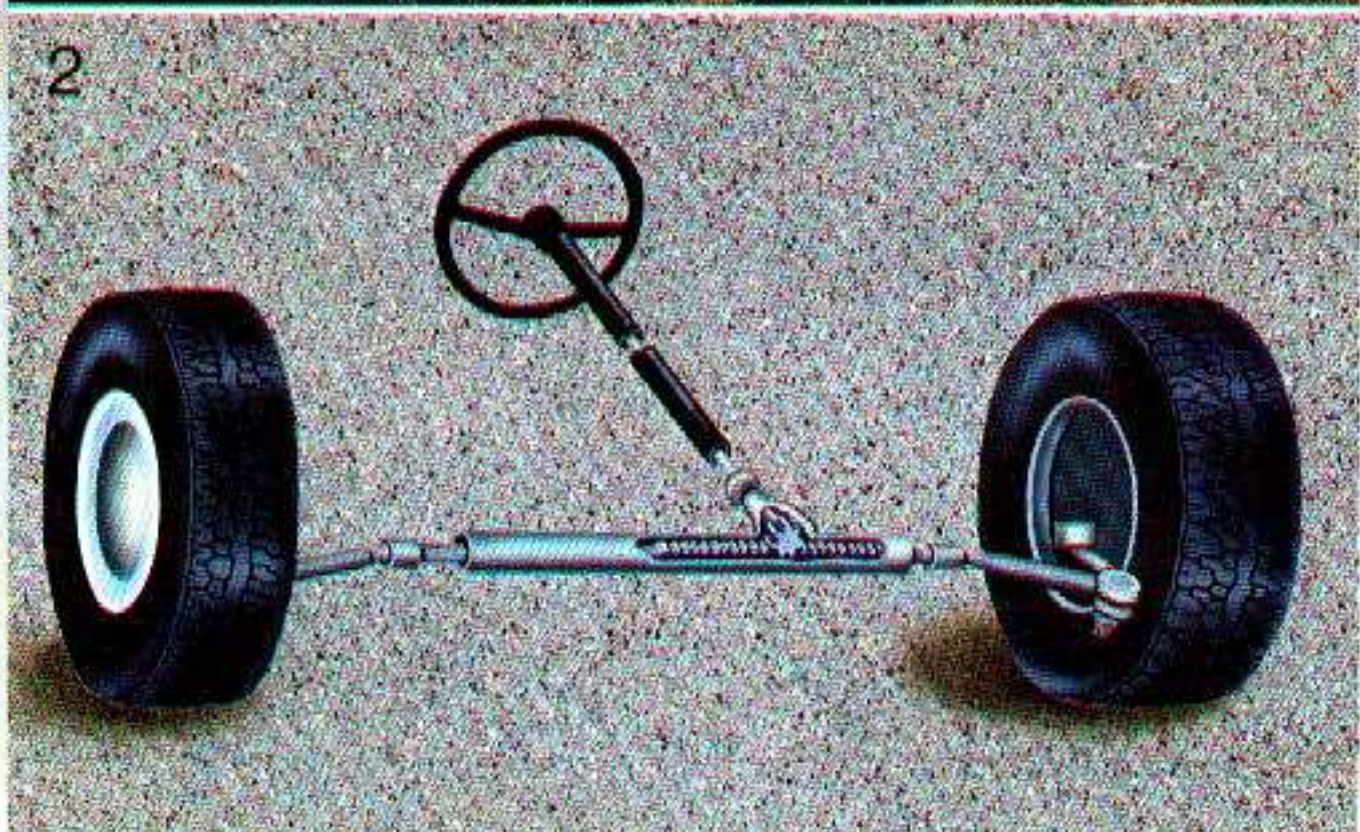

LEGO dacta

Technic

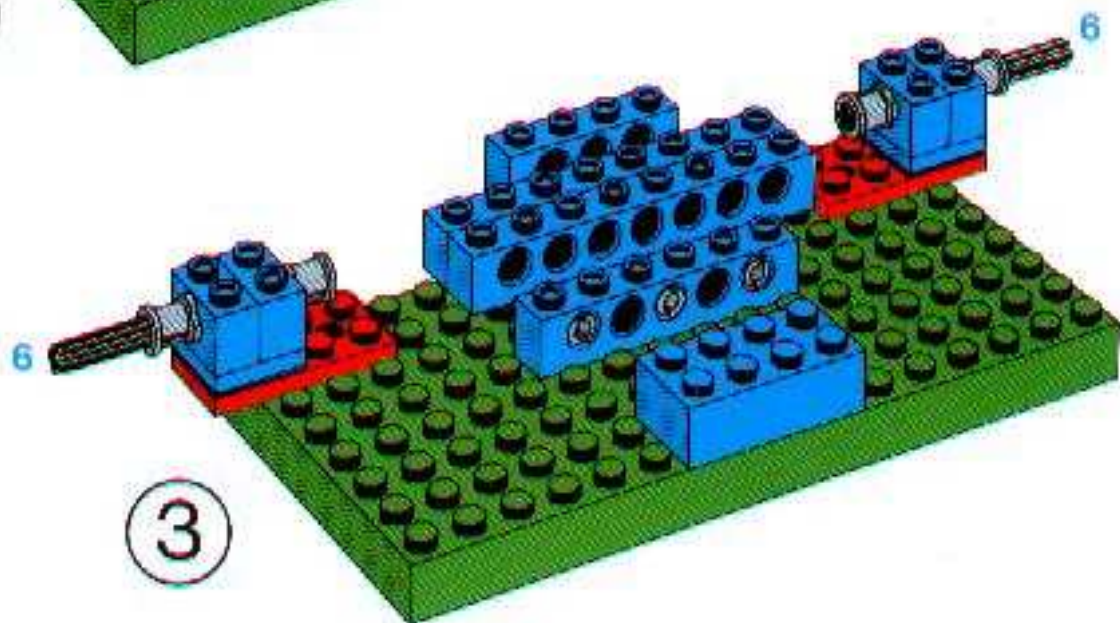
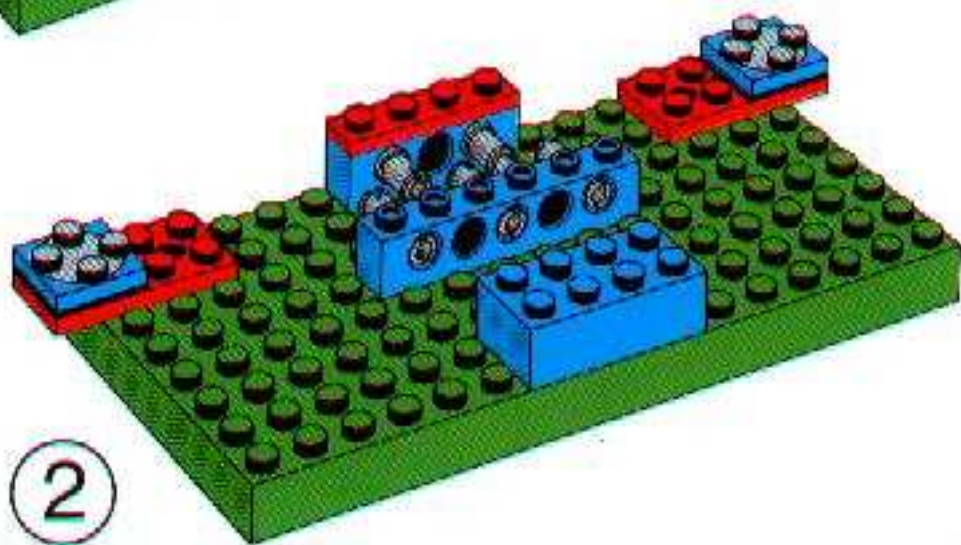
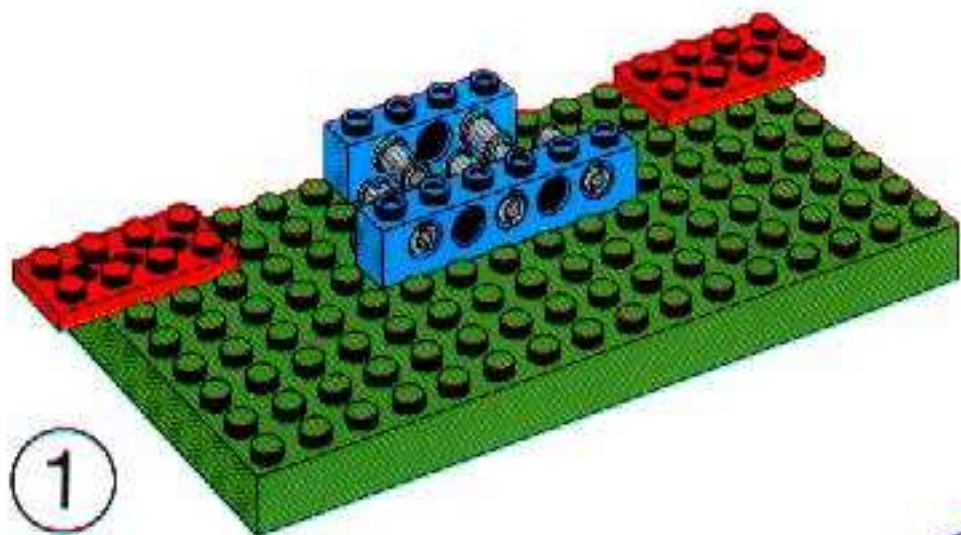
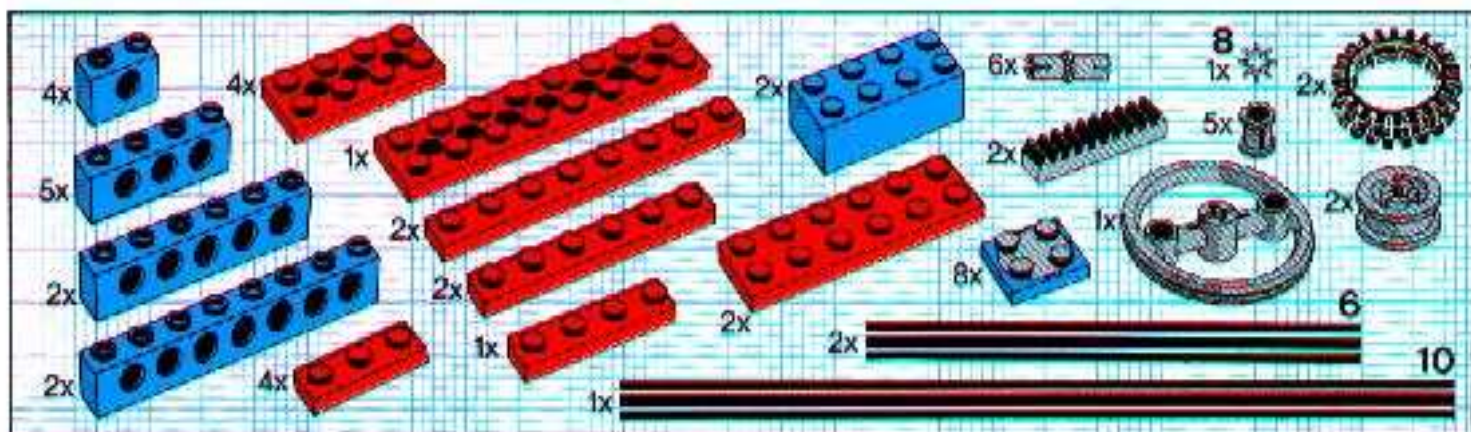

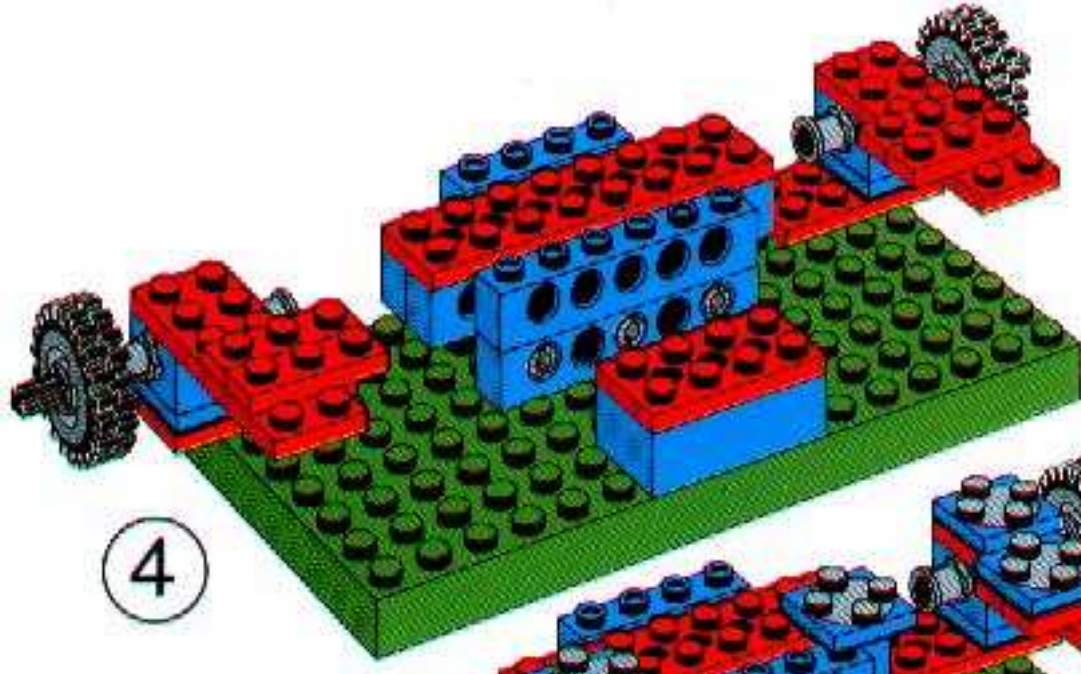

4

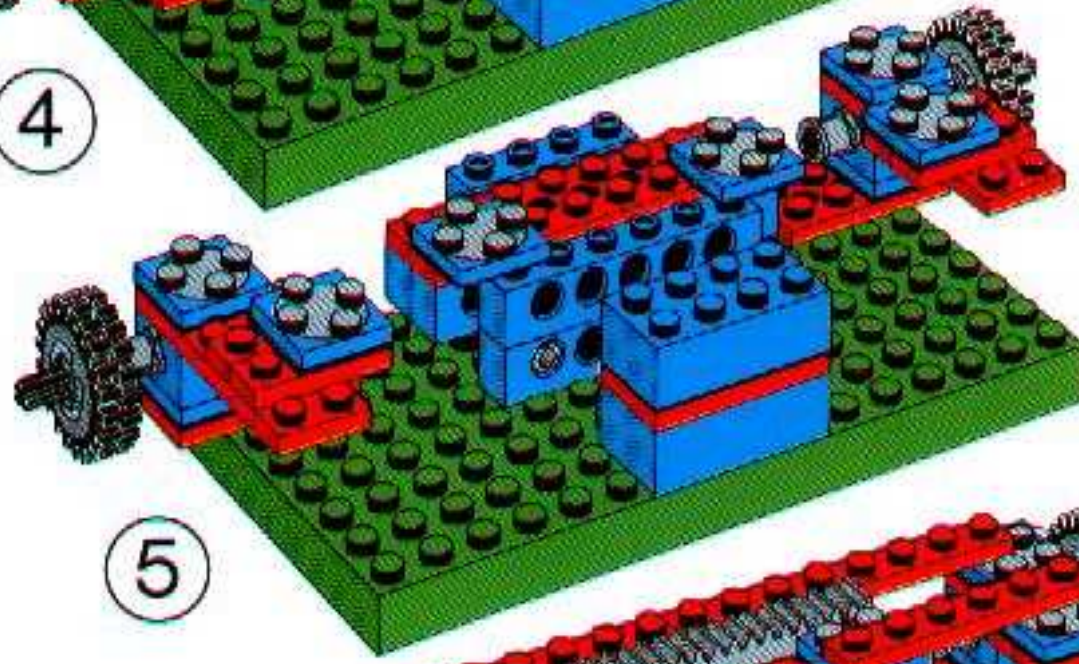

5

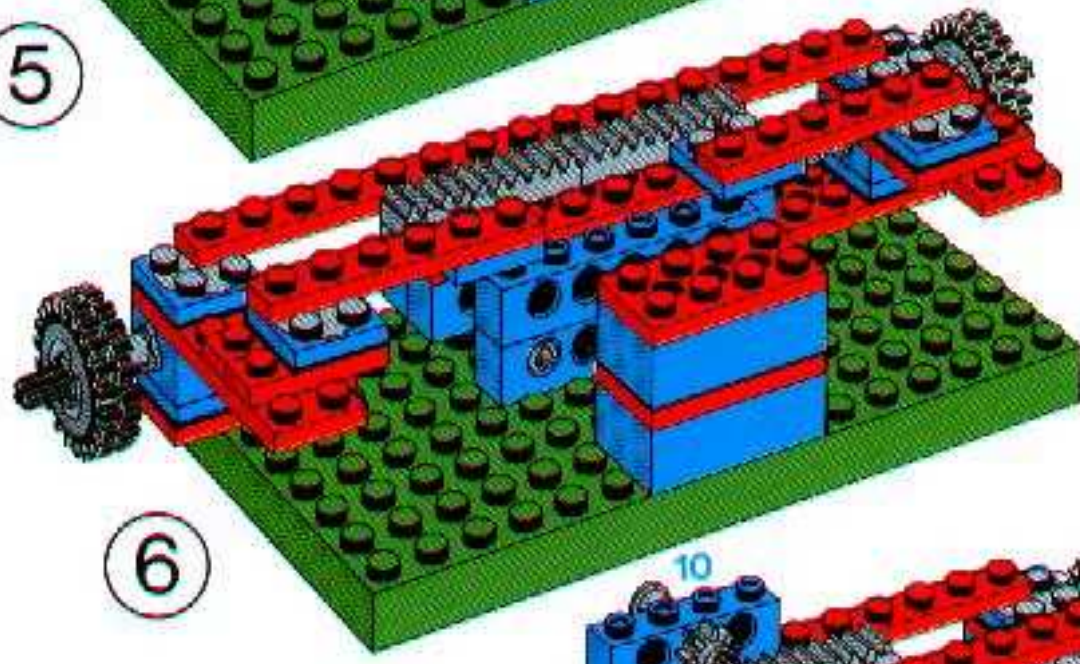

6

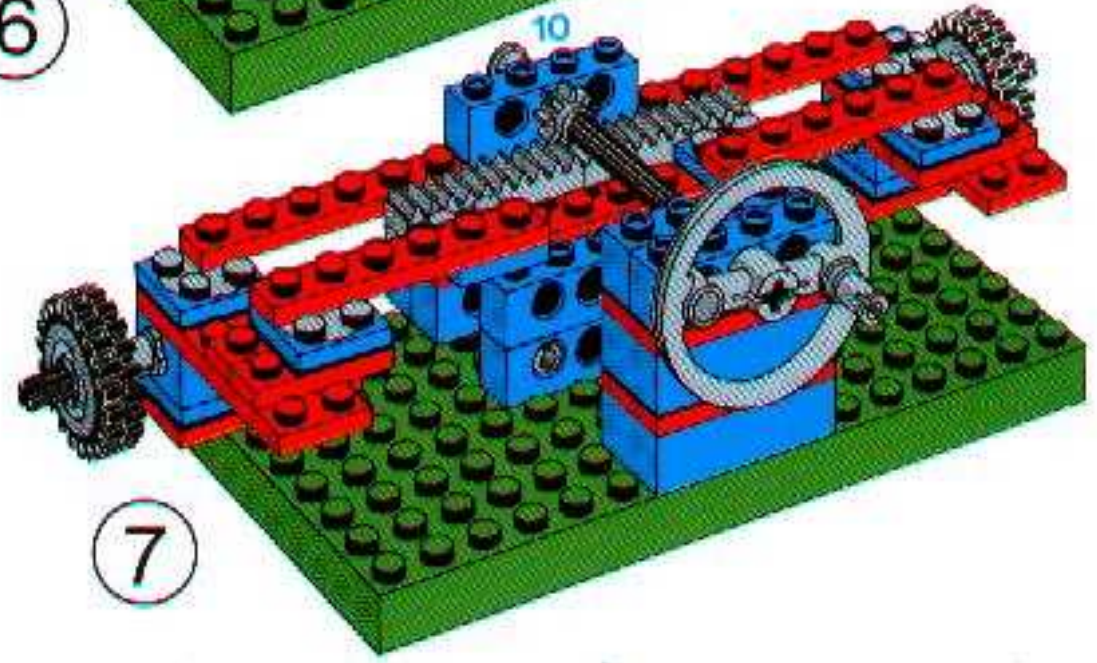

7

